

Kit Part Number: 700349

# Breathe Safe

Part of **Aire Safe**

## Parts and Service Manual

# KOMATSU

## D10T / D11T DOZER

HEPA H14 Variable Speed Pressuriser | OnGuard Air Quality Monitoring & Control | HEPA Return Air Filter



+61 7 3276 7833



[www.breathe-safe.com.au](http://www.breathe-safe.com.au)



[sales@breathe-safe.com](mailto:sales@breathe-safe.com)



62 Mica Street, Carole Park, 4300, QLD

Controlled Document: M0138

Issue Date: 08/09/23

Revision: 1

## INSTALLATION

### CONTENTS

- Installation ..... 1
- Safety..... 2
- Critical Parts & Maintenance Schedule ..... 3
- Specifications - Pressuriser ..... 4
- Parts List ..... 5-6
- Smoke Emitter Cabin Pressure Leak Test..... 7
- Technical Details..... 8
- Looms ..... 9-10
- Commissioning Procedures ..... 11
- User Settings Instructions ..... 12-20
- Warranty..... 21

### INSTALLATION OVERVIEW

<b>Manufacturer</b>	Komatsu
<b>Type</b>	Dozer
<b>Model</b>	D10T / D11T
<b>Cabin Pressure Max</b>	>250 Pascals
<b>Set Auto Cabin Pressure</b>	50 Pascals / 20 Pascals

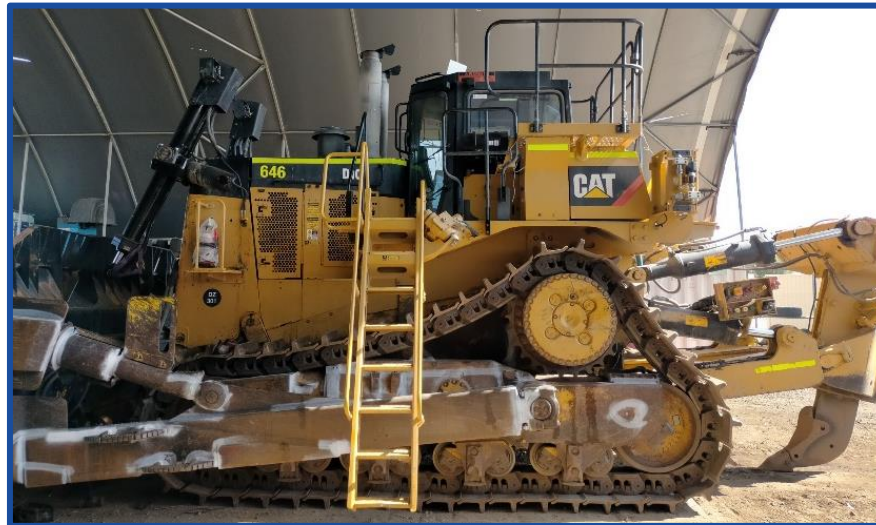

**HEPA H14 Variable Speed Pressuriser**



**OnGuard Air Quality Monitoring & Control**



**HEPA Return Air Filter**

## WARNING

THE PRESSURISATION SYSTEM DESCRIBED IN THIS MANUAL HAS THE FOLLOWING AREAS WHICH MAY BE DANGEROUS IF NOT TREATED WITH GREAT CARE.

QUALIFIED STAFF MUST WEAR THE CORRECT PERSONAL PROTECTIVE EQUIPMENT WHEN CLEANING AND SERVICING THIS UNIT DUE TO DUST AND FIBRES WHICH MAY BE CAUGHT BY THE STAGES OF AIR FILTRATION DURING NORMAL UNIT OPERATION.

THE ELECTRICAL POWER SYSTEM IS SUPPLIED BY 12V DC OR 24V DC AND NO WORK SHOULD BE CARRIED OUT ON THE PRESSURISER SYSTEM WITHOUT THE CORRECT SAFE WORK PROCEDURES AND ELECTRICAL SAFETY MEASURES BEING TAKEN, AND ALL RELEVANT CIRCUIT BREAKER OPENED TO ISOLATE THE CIRCUIT.

THE AIR FILTRATION SYSTEM MAY HAVE SEVERAL TYPES OF HIGH-SPEED ROTATING EQUIPMENT INSTALLED WITH VERY SHARP EDGES. ENSURE ALL SAFETY GUARD ARE IN PLACE WHILE THE SYSTEM IS RUNNING.

**Please be aware that HEPA filters cannot be cleaned and must be replaced at the end of their lifecycle or if filter media has been damaged.**



Hard hat



Eye protection



Dust mask



Ear protection



Protective clothing

### Particulate Behaviour

This is the length of time it takes for a particle to drop from a height of 1.5m in **STILL** air.



Warehouses and workshops do not have still air, so hazardous airborne particulates may remain in air for longer, increasing chance for workers to breathe in dust. Ensure PPE is worn when installing this system.



## CRITICAL PARTS & MAINTENANCE SCHEDULE

### Maintenance Schedule

The following tables show our suggested maintenance schedule for all units. Please note that site conditions may alter this.

Excludes high corrosion environments.

Data download is required to claim the 3-year warranty on Brushless Blower Motor.

### Inspect every 500 Hours and replace when filter is full\*

Component / System	Action Required
Turbo Pre-cleaner	Check operation of the Turbo Pre-Cleaner.
Pressuriser Blower	Ensure blower is operational.
HEPA Primary Filter p/n: <b>500000</b>	Inspect filter capacity indicator. Replace HEPA filter when 80% or greater. Vacuum out housing before replacing the filter elements.
HEPA Return Air Filter P/N: <b>500016</b>	Vacuum inside cabin floor before replacing filter.
Filter Frame Assembly, Mounts, Seals and Filter Housing	Check door seals, all bolts, screws, and all mounts are secure. Check the filter canister & ensure it is correctly fitted. Check latches are operational and in good order. Replace / Re-tension fixtures and fittings required.

### 15,000 Hours / 36 months\*

Component / System	Action Required
500 Hour Inspection	All 500-hour inspection actions.
Pressuriser's Blower <b>200002</b>	Replace BRUSHLESS Pressuriser blower.

Critical Parts				
Item	Part Number	Qty.	Description	Service Interval
1	500000	1	Fresh Air HEPA H14 Filter (Tested as per EN1822)	1000* Hours (>80% fan capacity)
2	500016	1	HEPA Return Air Filter	500* Hours
3	200002	1	Brushless Blower Motor – 24V	15,000 Hours
4	200018	1	OnGuard Main Unit Active	
5	200019	1	OnGuard UI	
6	200021	1	OnGuard Breathing Zone Sensor Pod	

\*Filter service hours are subject to cab sealing efficiency, site conditions and correct system use.

### Suggested Schedule Servicing\*



### Fan Capacity Indicator

The filter is serviceable if the motor capacity is between 10% & 80%. We recommend that the filter is changed if the capacity is over 80%.

\*Site dependent

## Specifications High-Capacity HEPA Pressuriser

Blower	: Brushless Blower P/N 200002.
Protection	: Locked Rotor Protection (Sub Zero Environments) Under Voltage, Under/Over Current & Over Temperature.
Voltage	: 24VDC.
Current Draw	: 11 amps (peak). *Note: Motor has slow start to stop excessive in-rush current.
Air Flow	: Up to 30-300 m <sup>3</sup> /h or 50-215 CFM.
Pre-cleaner	: Integrated VLR (Very Low Restriction). Turbo Pre-Cleaner.
Filter Element	: BreatheSafe HEPA Primary Filter (H14=99.99% MPPS) TESTED AS PER EN1822 – P/N 500000.
Plugs & Fittings	: Mining Spec. Deutsch electrical plugs as standard.
Construction	: High strength composite construction.
Serviceability	: Easy access HEPA filter with twist-lock (TL) dust cap single assembly.
Mounting	: Heavy Duty adjustable mounting brackets.
Design	: Fully designed in SolidWorks 3D CAD & Ansys Engineering Simulation Software.
FEA Testing	: Critical components FEA (Finite Element Analyst) tested in Solid Works Simulation.
CFD Testing	: CFD (Computational Fluid Dynamics) simulations in Flow Works to ensure optimum air flow through the system.

## SPECIFICATIONS HIGH-CAPACITY HEPA PRESSURISER

List of Abbreviations	
<b>DH</b>	Dual HEPA
<b>DHPR</b>	Dual HEPA Powered Recirculation
<b>DHAC</b>	Dual HEPA Activated Carbon
<b>DHACPR</b>	Dual HEPA Activated Carbon Powered Recirculation
<b>CPM</b>	Cabin Pressure Monitor
<b>CPU</b>	Central Processing Unit
<b>DB</b>	Decibel Sensor
<b>DPM</b>	Diesel Particulate Matter
<b>GAS</b>	Gas Sensor
<b>HEPA</b>	High-Efficiency Particulate Air Filter
<b>HPAFU</b>	High Pressure Air Filtration Unit
<b>HRAF</b>	HEPA Return Air Filter
<b>HVAC</b>	Heating Ventilation and Air Conditioning
<b>MAF</b>	Mass Air Flow
<b>OEM</b>	Original Equipment Manufacturer
<b>PM</b>	Particulate Mass
<b>RH</b>	Relative Humidity
<b>TEMP</b>	Temperature
<b>TS</b>	Touch screen
<b>UI</b>	User Interface
<b>VMS</b>	Vehicle Monitoring System
<b>VS</b>	Vibration Sensor
<b>OGSP</b>	OnGuard Sensor Pod
<b>CO2s</b>	CO2 Sensor INPRESS TS

Item No.	Qty.	Description	Part No.
1	1	Pre-cleaner Hood & Rotor Assy	200004
2	4	Pre-cleaner Injector Ring	200005
3	1	TL Fan Blade (inc. in #7)	200006
4	1	TL Nose Cone / Pre-cleaner	200007
5	1	TL Motor Housing	200008
6	1	TL Filter Housing	200009
7	1	24v DC Brushless VSD Motor & TL Fan Blade	200002
8	1	O Ring Seal Kit 2 Parts	200010
9	1	Included in 8	200011
10	1	Wiring Sleeve	200012
11	1	HEPA H14 Filter	500000
12	3	M6 Nyloc Nut	300218 (M6NYL)
13	3	M6 x 55mm Hex Bolt	300982 (M655B)
14	4	M8 x 190 Hex Bolt	301136 (M8190B)
15	8	M8 x 22mm O/D HD Washer	300230 (M8222HTW)
16	4	M8 Nyloc Nut	300249 (M8NYL)
17	5	M4 x 75mm Pan Head Phillips Screw	300162 (M475PBH)

PARTS LIST – TL4 24V DC PRESSURISER UNIT

PRESSURISER ASSEMBLY No: **200000**

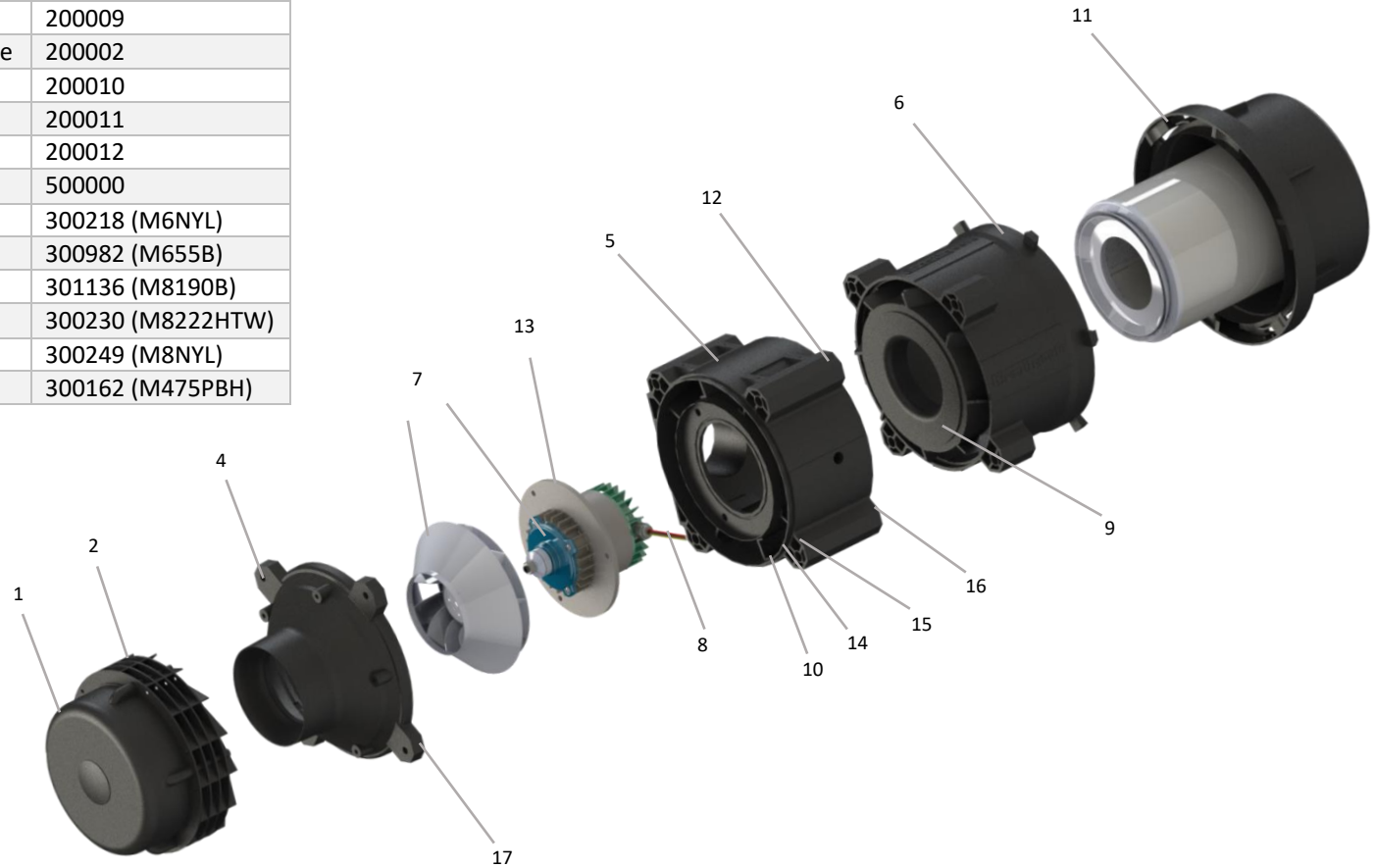

Please note the likely exposure to mine dust from handling used filters and observe health & safety directives (RPE/PPE)

Item No.	Part No	Rev	Description	Qty	Colour	Group

PARTS GA

COMPLETE ASSEMBLY No:

\* Do not handle until MSDS & all safety precautions have been read and understood. Use personal protective equipment as required.

Before use, carefully read the product label. Safe work practices are advised to avoid eye or skin contact and inhalation. Observe good personal hygiene, including washing hands before eating. Prohibit eating, drinking, and smoking in contaminated areas. Avoid inhalation. Mechanical extraction ventilation is recommended when the removal of atmospheric contaminants is required. Maintain dust / fume levels below the recommended exposure standard. For small amounts, absorb with sand, vermiculite or similar and dispose of at an approved landfill site.

### WARNING

- For Professional Use Only – keep out of reach of children.
- Do not ignite near or around flammable materials.
- Use only in well-ventilated areas, outdoors, and/or with proper respiratory protection.
- Persons with respiratory sensitivity should avoid exposure to any smoke.
- Concentrated smoke may cause severe burns to the skin, eyes, or respiratory system.
- Improper use may result in sufficient inhalation of smoke to cause respiratory tract irritation and lung damage.
- Harmful if swallowed.

### DANGER

Use only as directed. Do not handle until all safety precautions, including Safety Data Sheet, have been read and understood. The product contains hexachloroethane. Wear protective clothing. If exposed or concerned, get medical advice. Store in a cool, dry, secure location. KEEP OUT OF REACH OF CHILDREN. Dispose of contents/container per location regulations. When used as directed, exposure should be limited and usually poses no hazard because the hexachloroethane is consumed inside the tube as smoke is produced.

### Directions: (Smoke Bomb)

1. Ensure other workers in close proximity are informed of use. Place on a non-combustible container, away from flammable materials.
2. Place at Blower intake, or upwind of target area, or near centre of space.
3. Orient "Smoke Issues Here" toward air stream, away from surfaces. Place candle on a flame / heat resistance plate – if not it will melt into the plastic surface.
4. Ensure smoke will not create any hazard where it is anticipated to go.
5. Ignite emitter inside the cabin using site approved device i.e., solder torch or 'lighter' and conduct smoke test.
6. Do not touch or hold smoke generator after ignition – item becomes very hot & remains hot after use.

### Smoke Emitter Cabin Pressure Leak Test





1. The pressuriser system is switched on (TEST MODE).
2. Hold the smoke emitter angled down.
3. Ignite emitter using site approved ignitor i.e., solder torch or 'lighter'.
4. When the product ignites, remove the lighter.
5. If the product flames up, blow out the flame.
6. Place the emitter in a non-flammable container and place it inside the cabin at floor level and close the door/windows.
7. Observe smoke leaks to indicate worn-out or broken seal locations. Check leakage points outside the cabin.
8. Do not come into contact with or inhale smoke haze.
9. Wait until the smoke haze **completely** disperses before re-entering the cabin. Open door to allow sufficient ventilation of smoke prior to entering cabin.

\*This SWP does not necessarily cover all possible hazards associated with this equipment and should be used in conjunction with other references. It is designed as a guide to be used to compliment training and as a reminder to users prior to equipment use.



## SMOKE EMITTER CABIN PRESSURE LEAK TEST

Link to MSDS: [SMOKE GENERATOR TQ7621AT30S.pdf](#)



### Personal Protective Equipment (PPE)

	Safety glasses must be worn at all times.
	Sturdy footwear with rubber soles must be worn.
	Respiratory protection devices may be required.
	Gloves may be worn.

### Pre-operational Safety Checks

	Locate and ensure you are familiar with all machine operations and controls.
	Check work area and walkways to ensure no slip/trip hazards are present.
	Ensure the work area is clean and clear of any flammable material & fire extinguish device is present.





### Operational Safety Checks

	Ensure the machine is correctly isolated / immobilized.
	Ensure other persons do not inhale smoke haze.
	Take care and do not place a lit emitter close to a flammable surface.

### Ending Operations and Cleaning Up



	Leave the work area in a safe, clean, and tidy state.
---	---

### Potential Hazards

	Falls
	Fumes
	Fire
	May cause cancer

Exposure is highly unlikely when the product is used as directed. Direct contact with the product does not occur.

### Don't

	Do not use if an open flame is forbidden.
	Never leave the emitter [cabin test] unattended.



## Wiring Diagram

### TECHNICAL DETAILS

Reference	Part	Part Number
1	OnGuard Main Unit Active	200018
2	OnGuard Breathing Zone Sensor Pod	200021
3	OnGuard Return Air Zone Sensor Pod	200020
4	OnGuard User Interface	200019
5	TL4 Pressuriser	200000
6	HEPA H14 Fresh Air Filter	500000

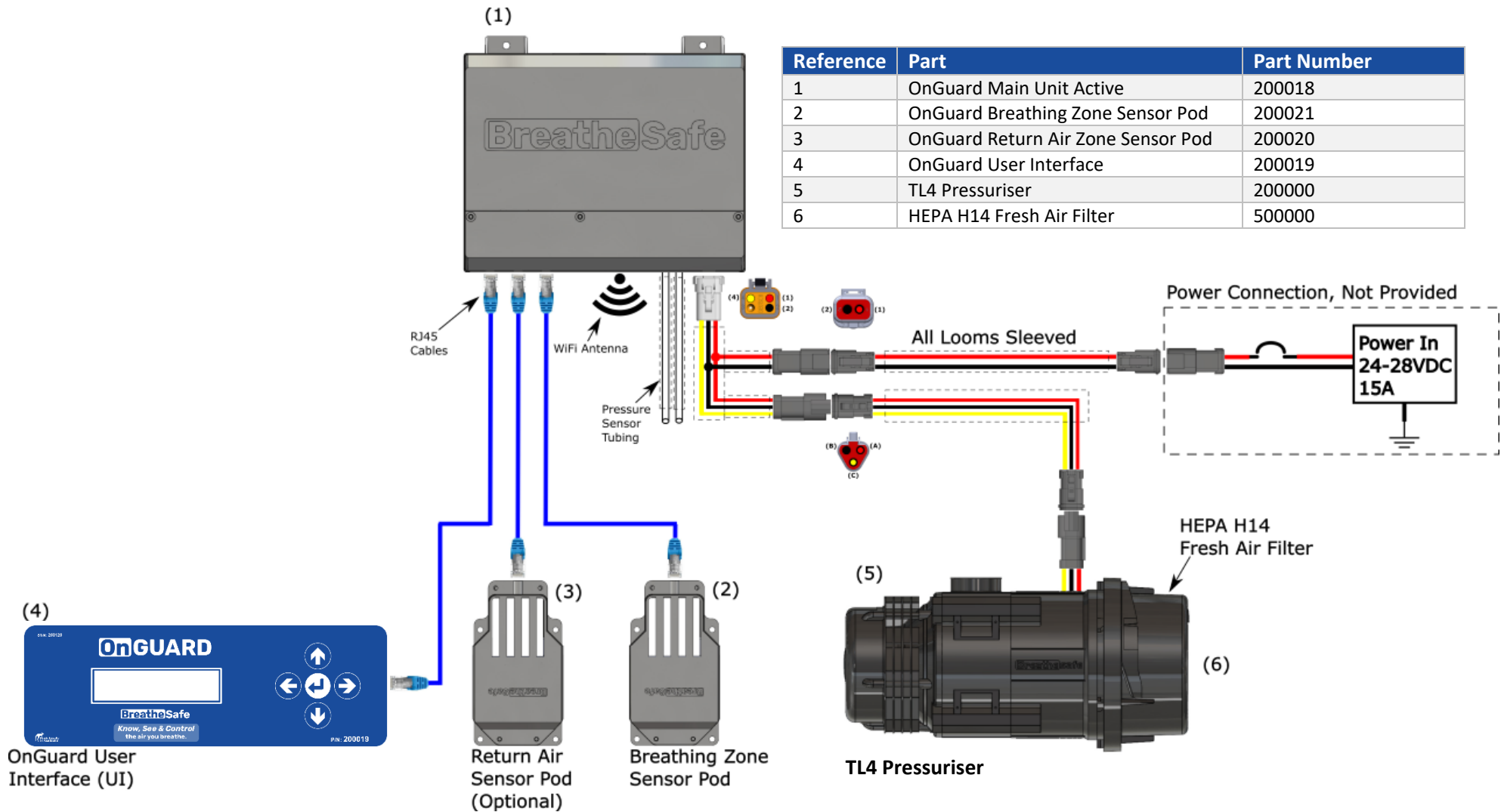

Item No.	Part No.	Rev	Description	Qty	Colour	Category
1	400009 (L100009)	N/A	4 Pin 0.5m Master Controller Loom	1	-	Stock Item

**PARTS LIST – MASTER CONTROLLER LOOM**

**WIRING LOOM No: 400009**

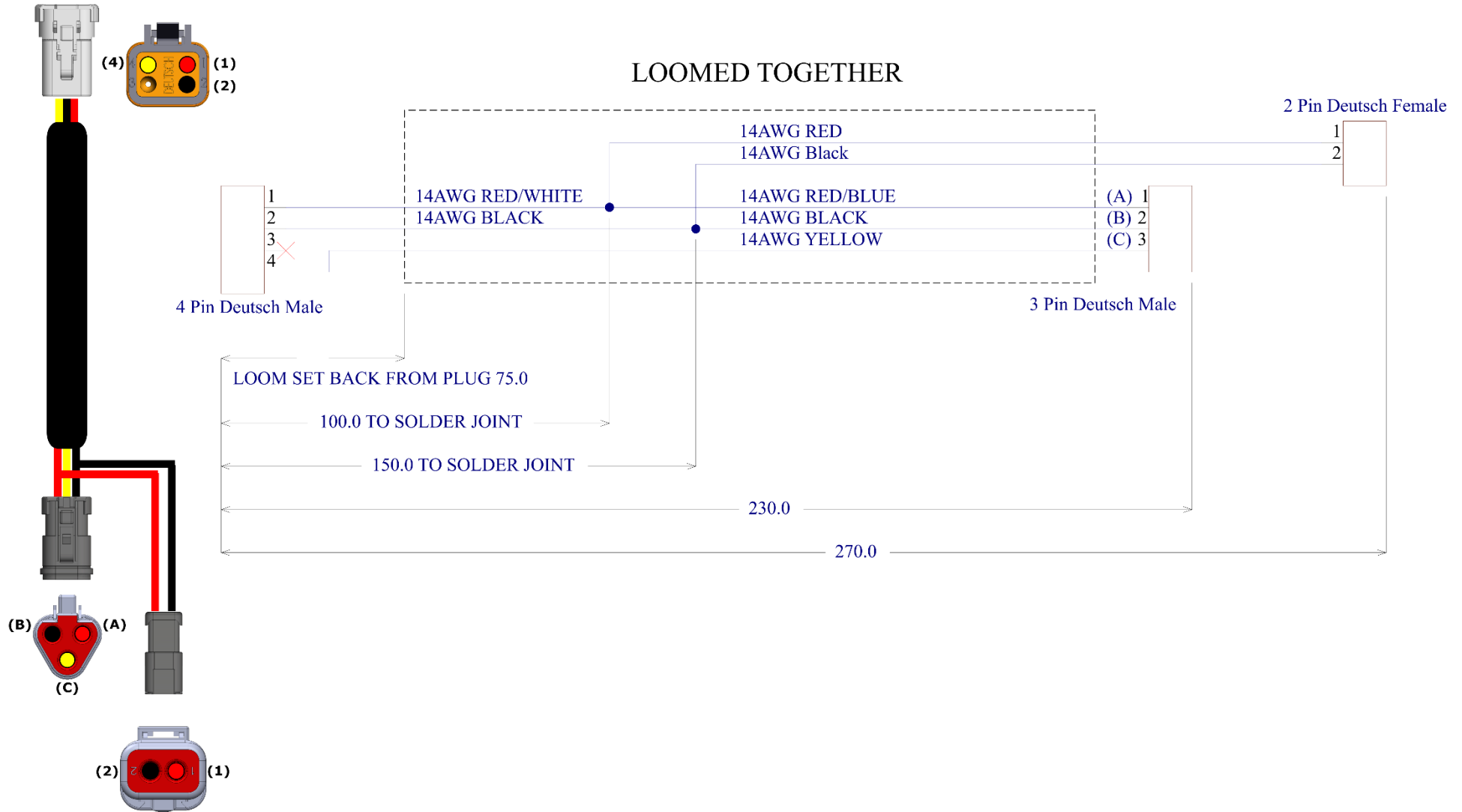

Item No.	Part No.	Rev	Description	Qty	Colour	Category
1	400002	N/A	2 Pin 5m Main Power & Earth Supply Loom	1	-	Stock Item
2	400003	N/A	3 Pin 5m Power, Earth & Speed Control Loom	1	-	Stock Item
3	400004	N/A	5m Air Pressure Sense Pipe w/ Sleeving	1	-	Stock Item

PARTS LIST – PIN LOOMS & AIR PRESSURE PIPE

**WIRING ASSEMBLY No: 400001**

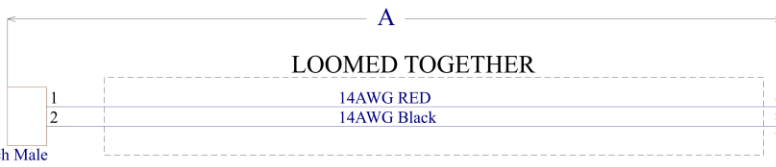
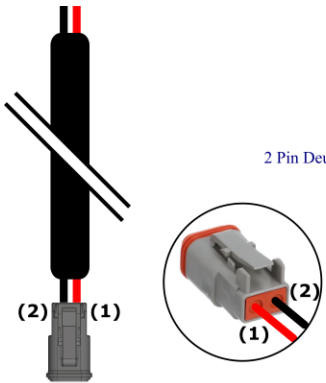

Part Number	Dimension A
<b>400002 (L100002)</b>	5000.0 mm
To be Advised	-
To be Advised	-
To be Advised	-
To be Advised	-
To be Advised	-
To be Advised	-
To be Advised	-

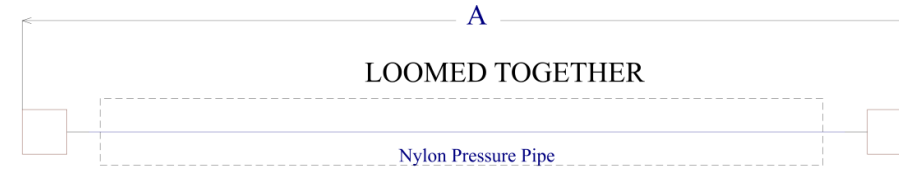

Part Number	Dimension B
<b>400004 (L100004)</b>	5000.0 mm
To be Advised	-
To be Advised	-
To be Advised	-
To be Advised	-
To be Advised	-
To be Advised	-
To be Advised	-

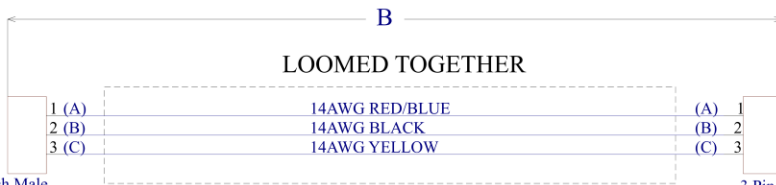
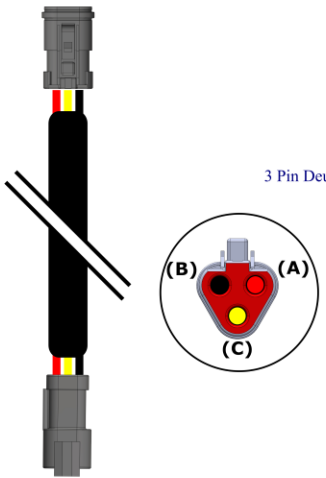

Part Number	Dimension B
<b>400003 (L100003)</b>	5000.0 mm
To be Advised	-
To be Advised	-
To be Advised	-
To be Advised	-
To be Advised	-
To be Advised	-

3 Pin Deutsch Female

\*Plug Assemblies Provided Loose

### Commissioning Procedures

### COMMISSIONING PROCEDURES – CABIN PRESSURISER

Follow each step of the installation guide that was supplied with the BreatheSafe kit.

Cabin sealing is an integral part of RS20 & ISO 23875; you must ensure that cabin seals are adequate for maintaining positive pressure. In addition, the site (end- user) must have the correct procedure(s) for servicing OPERATOR enclosure seals in a proactive manner rather than reactive. Items such as door and window seals must be in good working order or new seals FITTED before the BreatheSafe system installation.

#### How to run Max Speed Commissioning Test

1. Open the 'action menu' by holding down the centre enter (↵) button or by pressing the up (↑) and down (↓) buttons at the same time.
2. If not already displayed, press the down (↓) button to cycle through the menu options until the 'Max Speed Test' option is displayed
3. Ensure the cabin door and windows are completely closed.
4. Press Enter to begin a max speed test.

Submission for commissioning procedure as per the diagram below:

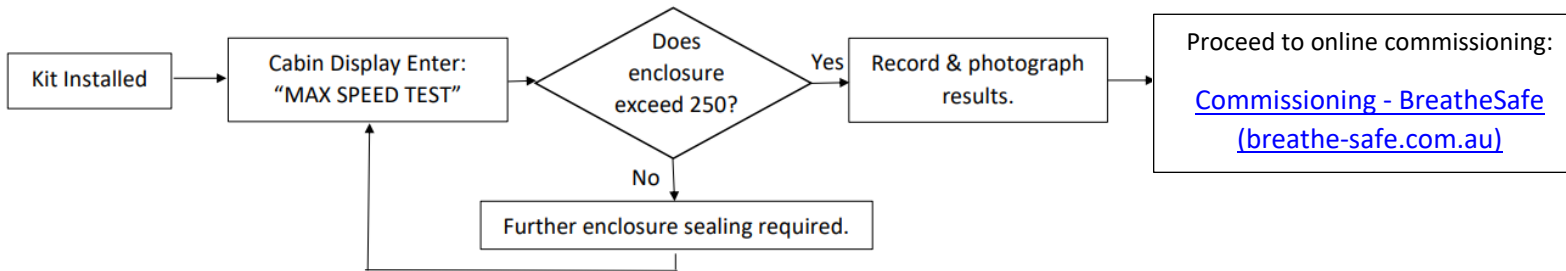

**BreatheSafe**  
Part of AireSafe

Commissioning Certificate

Customer Details: Company, Customer Email, Customer PO Reference, Job Reference No, Location (Australia), Collaborator Name

Date of Issue, Date of Installation/Commissioning, Installer/Commissioning Technician Name, From Company, Company / Agent, Installation Location (Same as customer location)

Machine Details: Brand (CATERPILLAR), Type (Load Truck), Model, Feet No, VIN / Serial No, Machine Age

BreatheSafe System: Pressuriser Model (TLK), Pressuriser Serial No, Monitor Model (EXPRESS TS), Monitor Serial No, Fresh Air Filter P/N, Return Air Filter P/N, A/C Carbon Filter P/N

Removed Parts/Filters: Fresh Air Filter P/N, Return Air Filter P/N

Commissioning and Calibration Results: Date of Test, Max Pressure (Pa), Pressure Setpoint (Pa), Actual Pressure (Pa), Motor Load (%)

Narrower Real Time Cabin Results: Tested at A/C vent, Tested in Breathing Zone

Warning: BreatheSafe Speed Motor - 3 years or 15,000 hours extended warranty

Installation Notes

The commissioning images required are:

- ID plate / Machine Serial Number / Asset Number or Call Sign
- INPRESS TL Pressuriser location
- HEPA Return Air Filter Location Option: Powered Return Air Filter
- Cabin Pressure Display Location – Including the “System Check” maximum cabin pressure result with motor output capacity %

Fill in the BreatheSafe Service Tag with the following details:

- Machine Serial Number and Installers details
- Date installed and System Check result (max cabin pressure)
- The set cabin pressure with actual pressure and motor percentage output
- Verify the 250-pascal threshold was achieved = pass OR not achieved = fail\*\*

**BreatheSafe**  
Part of AireSafe

AIR CONDITIONING FAN MUST BE TURNED TO MEDIUM SPEED TO CIRCULATE AIR & MINIMISE CO<sub>2</sub> LEVELS.

MACHINE SN: BREATHESAFE CONTROLLER SN:

DATE INSTALLED: MACHINE HOURS:

AUTO PRE-SET PRESSURE (Pa): MAX CABIN PRESSURE (Pa):

NOTES (FILTER PART NUMBERS):

1 2 3 4 5 6 7 8 9 10 11 12 13 14 15 16 17 18 19 20 21 22 23 24 25 26 27 28 29 30 31

JAN FEB MAR APR MAY JUN JUL AUG SEP OCT NOV DEC

2023 2024 2025 2026 2027 2028

Technical Support Phone: 1300 667 597 | www.breathe-safe.com

Please upload machine and installation details in conjunction with the required images. A Commissioning Certificate will be sent to the email address you nominate. \*\*Extended warranty for (RS20 & ISO 23875) BreatheSafe Systems is only applicable to operator enclosures meeting this requirement.

## USER SETTINGS INSTRUCTIONS

### 1.0 HOW TO OPERATE THE UI

Controlling the UI is performed exclusively with the 5-button keypad located on right side of the UI.

- The up (↑) and down (↓) arrows are used to cycle through:
  - Menu Items (Functions or Configurations)
  - Characters/Numbers when editing a parameter
- The Left (←) and Right (→) arrows are used to:
  - Move between character selection when editing a parameter.
  - Navigate to the 'X', which will allow the user to exit the current menu/selection when activated
- The enter (↵) button is used to:
  - Enter a sub-Menu (for editing Configurations)
  - Confirm actions (when a parameter is set or to activate a function)

Pressing the enter (↵) button, will either activate the function shown on the screen or, if editing a parameter, will cycle to the next item in the configuration. Pressing enter (↵) at the end of a menu will return the user to the main menu.

### 2.0 HOW TO GAIN ACCESS TO THE OPERATOR AND ADMIN MENUS

1. Press the up (↑) and down (↓) buttons at the same time.
2. Press the down (↓) button until 'Admin Access' appears.



3. Locate the appropriate Access Credentials (Operator or Admin), these are provided on the info sheet. Example shown below.

**Default Access Credentials**

The factory default configuration contains the following passwords, which can be changed in the OnGuard Web Interface (by the "admin" user). These credentials work for both the Display Pod and the Web Interface.

Minimal Privileges: Username "operator", Password dr28  
 Full Privileges: Username "admin", Password gn79  
 Web API, read-only: Username "api", Password <Not Set, Inactive>

Figure 1: Excerpt from Info sheet showing access credentials

4. Enter the Access Pin. The up and down buttons are used for setting the character at the current cursor position. The right and left buttons are used for moving the cursor along.



5. Press the enter button.

**USER SETTINGS INSTRUCTIONS**

### 3.0 HOW TO ACCESS THE WEB INTERFACE VIA THE WI-FI ACCESS POINT (AP)

1. Open any Web Browser from a 2.4GHz Wi-Fi capable device
2. On the device, connect to the Wi-Fi network being hosted by the OnGuard. The details of the OnGuard's AP are found on the Info sheet (example shown below). These details are also shown in 'Net Config' in the Admin menu on the OnGuard UI.

#### Network Configuration

Your OnGuard unit supports Wired Ethernet and 2.4GHz WiFi, and currently the stand-alone WiFi Access Point connection is configured for automatic starting. You can change the network settings using the OnGuard Web Interface (or the Display Pod, which also lets you stop or start all connections).

Wired Ethernet: Inactive  
Address: Dynamic Address Assignment (DHCP)

WiFi Access Point: Autostarted at Boot  
WiFi Net Name: **bsafe\_127a**  
WiFi Password: **w94vhuuw**  
Address: **Static Address 192.168.7.1**, Netmask 255.255.255.0, No Gateway

WiFi Client: Inactive  
WiFi Net Name: <Not Set, Inactive>  
WiFi Password: <Not Set, Inactive>  
Address: Dynamic Address Assignment (DHCP)

Figure 2: Excerpt from Info sheet showing OnGuard's AP

Note: This network name and password is an **example only**. Refer to the provided info sheet for the appropriate network name and password.

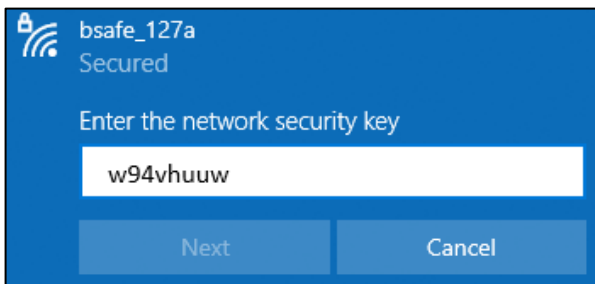

3. Open a web browser. Enter the IP address of the OnGuard Access Point (AP) into the address bar (Default is 192.168.7.1 for all OnGuard Kits).

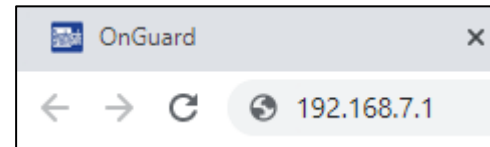

4. The client will be prompted to enter a username and password. These are the same access credentials as for the OnGuard UI. 'admin' or 'operator' must be entered as the username and the respective pin must be entered as the password.

#### Default Access Credentials

The factory default configuration contains the following passwords, which can be changed in the OnGuard Web Interface (by the "admin" user). These credentials work for both the Display Pod and the Web Interface.

Minimal Privileges: Username "operator", Password **dr28**  
 Full Privileges: Username "admin", Password **gn79**  
 Web API, read-only: Username "api", Password <Not Set, Inactive>

Figure3: Excerpt from Info sheet showing access credentials

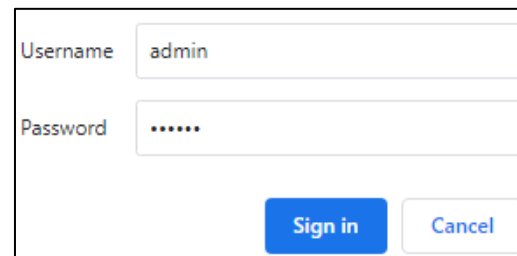

## USER SETTINGS INSTRUCTIONS

### 4.0 HOW TO CONFIGURE THE ONGUARD TO CONNECT TO AN EXTERNAL WI-FI NETWORK VIA THE WEB INTERFACE

1. Connect to the web interface via the Access Point (See Section 2.0)
2. Ensure client is logged in as 'admin'
3. Click 'Edit' under 'Current Configuration' heading

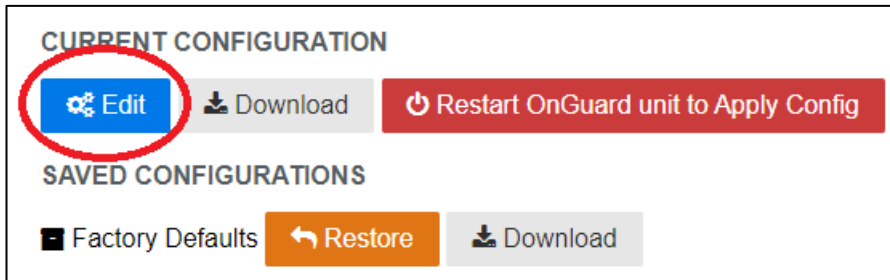

4. Scroll down to 'WiFi, Client Mode'

WiFi, Client Mode ▾

Join network at startup?  
yes ▾

Network Name:

Password:

IPv4 Address:

Netmask Length:

Gateway Address:

Nameserver Address:

WiFi Client (STA) mode is independent of the Embedded Access Point, the unit's current IP address can be found in the Operator's UI menu.

5. Enter the details of the network the OnGuard will connect to under 'Network Name' and 'Password'
6. Click 'Save Changes'
7. Click 'Restart OnGuard unit to Apply Config'

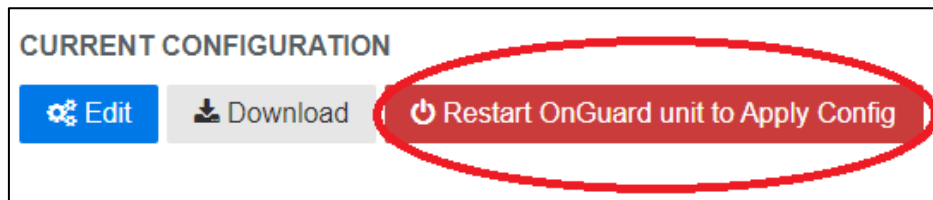

8. Once the OnGuard has restarted, reconnect to the web interface via the AP
9. Navigate to 'Help' -> 'About'

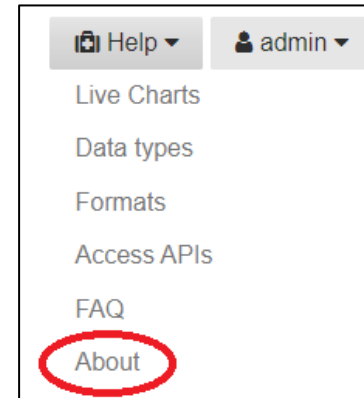

10. Verify the OnGuard has successfully connected to the Wi-Fi network by checking that 'WiFi Client' is 'Up' and has an IP Address assigned. If the status of the Wi-Fi Client is 'Down', manually restart the OnGuard Main Unit by turning it off and then powering it back on after 10 seconds.

	Connection Type	Status	IP Address
Network Connections	WiFi Access Point	Up	192.168.7.1
	WiFi Client	Up	10.60.60.228
	Wired Ethernet	Down	

11. The OnGuard web interface can now be accessed on this network by navigating to the IP address displayed next to 'WiFi Client' (as above example) on any normal web browser.

## USER SETTINGS INSTRUCTIONS

### 5.0 HOW TO CONFIGURE THE ONGUARD TO CONNECT TO A STANDARD WI-FI NETWORK VIA THE USER-INTERFACE (UI)

1. Enter the Admin menu on the UI using the 'admin' pin (See Section 2.0)
2. Press the down (↓) button until the 'Net Config' option appears



3. Press the Enter button
4. Press the down (↓) button until the 'WiFi STA Config' option appears.



5. Press Enter
6. Enter the name of the Wi-Fi network for the OnGuard to join under 'STA



7. Enter the password for this network under 'STA Password:'



8. Select the addressing type by cycling through the options with the up (↑) and down (↓) buttons. The default option is dhcp and is standard for most networks. Consult your network admin to confirm the configuration of the network being connected to.



9. Press Enter
10. The UI will return to the Network menu. From here, scroll to the 'Autostart' option using the up (↑) or down (↓) button.
11. Press Enter. Verify the 'WiFi STA' is one of networks listed for automatic start at boot. Change the networks auto-started on boot using the up (↑) or down (↓) buttons.



## USER SETTINGS INSTRUCTIONS



12. Press Enter.

13. The UI will return to the Network menu. From here, scroll to the 'Start Net' option using the up (↑) or down (↓) button.



14. Press Enter

15. The UI will return to the Network menu. Confirm the OnGuard has connected to the desired network by navigating to 'Net Status'.

16. Press Enter until the status of 'WiFi STA' is shown:



17. The IP address displayed (10.60.60.72 in the example) is the address of the OnGuard web interface on the network. Navigate to this address via a web browser on a device connected to the same network to access the OnGuard's web interface.

## TROUBLE SHOOTING

1. If the network status in step 13 shows 'Wi-Fi STA: down', the OnGuard has not successfully connected to the network.
2. Verify all network details were entered correctly in steps 6-8.
3. Restart the OnGuard by powering off the Main Unit for 10 seconds.
4. Once the OnGuard has restarted, return to step 13.
5. Note: Sometimes multiple restarts are required.

## USER SETTINGS INSTRUCTIONS

### 6.0 HOW TO ADJUST OR DISABLE THE ALARMS ON THE UI

1. Enter the Admin menu on the UI using the 'admin' pin (See Section 2.0)
2. Press the down (↓) button until the 'LowPr. Alerts' / 'HighPr. Alerts' option appears
3. Press Enter to access the 'Buzzer Volume'
4. Use the up (↑) and down (↓) button to adjust the buzzer volume from 1 to 16, 16 being the highest.
5. To disable the buzzer, adjust the volume to 0.
6. Press Enter
7. If the buzzer is enabled (volume 1 or above), the 'Buzzer Type' option will appear.
8. Use the up (↑) and down (↓) button to adjust the buzzer type until a suitable buzzer has been selected.
9. Press enter to confirm selection.

### 7.0 HOW TO DISABLE/ENABLE DUST ALERTS ON THE WEB INTERFACE

1. Sign in to the Web Interface as 'admin' (see section 3.0)
2. Click 'Edit' under 'Current Configuration' heading



3. Scroll down to '[Sensor Name] Particulate Matter Sensor' (e.g. Breathing Zone Particulate Matter Sensor)

The image shows a settings screen for a 'Breathing zone Particulate Matter Sensor'. It has a light blue header with the sensor name and a small upward arrow. Below the header, there are three settings: 'High Dust Level Alert Enabled?' with a dropdown menu showing 'yes', 'PM<sub>2.5</sub> Alert Threshold (µg/m³)' with a text input field containing '25', and 'PM<sub>10</sub> Alert Threshold (µg/m³)' with a text input field containing '50'.

4. Click 'High Dust Level Alert Enabled?' and select 'no'

The image shows a dropdown menu for 'High Dust Level Alert Enabled?'. The menu is open, showing three options: 'yes' (selected), 'yes', and 'no'.

5. Scroll to the bottom and select 'Save Changes'.

## USER SETTINGS INSTRUCTIONS

### 8.0 COMMISSIONING: HOW TO RUN A MAX SPEED TEST

5. Open the 'action menu' by holding down the centre enter (↵) button or by pressing the up (↑) and down (↓) buttons at the same time.
6. If not already displayed, press the down (↓) button to cycle through the menu options until the 'Max Speed Test' option is displayed



7. Ensure the cabin door and windows are completely closed.
8. Press Enter to begin a max speed test.

### 9.0 COMMISSIONING: HOW TO RUN A PRESSURE TEST

1. Access the Admin menu on the UI using the 'admin' pin (See Section 2.0)
2. Press the down (↓) button until the 'Pressure Test' function is displayed.

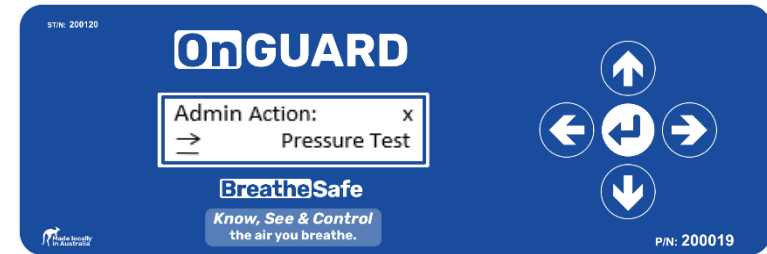

3. It is critically important that the cabin door and windows are fully **closed** during this operation. If the Minimum Pressure percentage is not reached, a Test Failure alert is raised.
4. Press Enter to begin a Pressure test.

## USER SETTINGS INSTRUCTIONS

### 9.0 HOW TO REPLACE A SENSOR POD

1. Switch off power to the OnGuard Main Unit, as it powers the Sensor Pod.
2. Remove the existing Sensor Pod from where it is mounted by removing the 4 M4 Bolts from the corners of the case, the mounting holes are shown in the figure below:

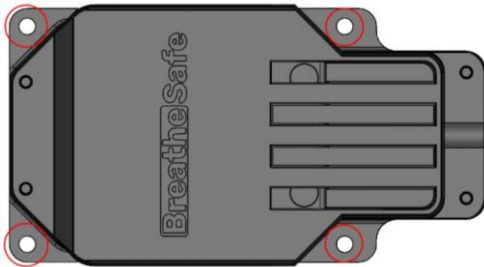

3. Find the replacement Sensor Pod, do not mount this in the previous Sensor Pod's place yet.
4. Remove the 4 M3 screws from the top of the sensor pod and remove the lid.

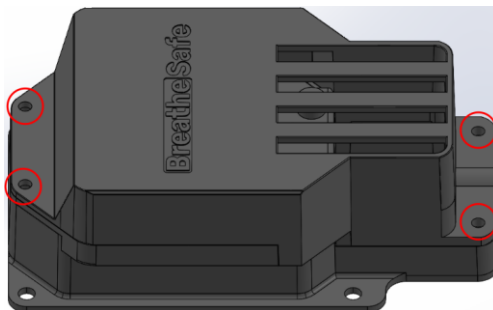

5. Plug the RJ45 cable used to power the previous Sensor Pod into the female port on the sensor board, clip facing upwards.

Note: Replace the RJ45 cable as well if there is any visible damaged to the cable or plug

6. Replace the lid, ensuring that the RJ45 cable is clamped in the hole between the lid and the base. Special care must be taken to ensure the 4 coloured wires inside the case are not clamped by the lid when putting it back on the case.
7. Replace the M3 screws. Do not over tighten the screws as excessive force will strip the threads inside the plastic.
8. Power on the OnGuard Main Unit.
9. Sign in to the Web Interface as 'admin' (see section 3.0)
10. Click 'Edit' under 'Current Configuration' heading

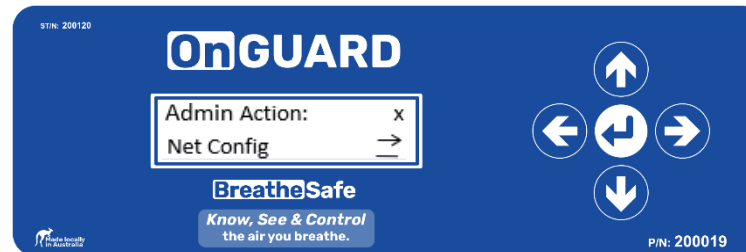

11. Scroll down to the 'Connect Accessories' heading

Connected Accessories			
Hardware Type	Hardware Serial Number	ID Tag	Assigned to Zone
CO <sub>2</sub> /PM Sensor	30		Return Air zone
CO <sub>2</sub> /PM Sensor	31		Breathing zone
Display Pod	12		

ⓘ This section lists all currently connected accessories with their (fixed) types and serial numbers. A (persistent) name may be set with the ID Tag field.  
 ⚠ All sensors **must be assigned** to sensor zones or they will be ignored!  
 If an accessory pod is replaced the zone assignment **must be updated** (because assignments are by serial number).

12. Verify the newly replaced Sensor Pod has successfully connected to the OnGuard by checking the number under 'Hardware Serial Number' matches the serial number on the sticker attached to the Sensor Pod.

Hardware Type	Hardware Serial Number
CO <sub>2</sub> /PM Sensor	30
Hardware Type	Hardware Serial Number
CO <sub>2</sub> /PM Sensor	31

13. Under 'Assigned to Zone', the new sensor will display 'None'. Click this drop-down menu and select a zone the same zone that applied to the replaced sensor pod. This will one of the zones that is **not** already assigned to another sensor pod.

For example, if the other connected sensor is assigned to 'Breathing Zone', the replacement sensor is most likely the 'Return Air zone' sensor.

Assigned to Zone

Return Air zone ▼

None

Breathing zone

Return Air zone

## WARRANTY

### Express Warranty

All BreatheSafe products carry a warranty against defects in materials or workmanship, provided the defects are not from factors outside of BreatheSafe's control (including neglect, lack of maintenance, improper installation or operation, unauthorized servicing repair, etc.). BreatheSafe will replace goods defected in material or workmanship at our Queensland factory or designated branch\*. All parts deemed as failed or faulty must be returned to BreatheSafe for evaluation unless otherwise stated in writing.

**Note-** Systems must be installed and commissioned as per BreatheSafe installation and commissioning instructions. Once commissioned, the online commissioning sheet must be filled in, extending the components warranty as below. In addition, the system must be serviced and maintained correctly and by trained and qualified personnel. This requisite includes BreatheSafe technicians, qualified automotive air-conditioning technicians, or qualified auto electricians.

### Warranty period – Standard

- 1 year or 10,000 hours (whichever occurs first).
- Controllers – 1 year no extended warranty option.
- Warranty Period Extension when commissioning documents are registered online within 28 days of installation
- Extended warranty\*\* only offered if commissioning maximum pressure test reaches at least 250Pa.
- Brushless motor fixed speed two years, or 10,000 hours (whichever occurs first).
- Variable speed brushless motor 15,000 hours, or 3 years\*\* (whichever occurs first).

Must be supplied with a variable speed pressure controller, data download required for 3-year warranty option. Link to online Commissioning and Extended Warranty Registration form <https://www.breathe-safe.com.au/commission/>

### What is not covered under Express Warranty?

- Failures are due to incorrect application.
- Damage resulting from neglect, misuse, lack of maintenance, improper installation, or operation, inappropriate or abnormal use, accidental or unauthorized servicing repair.
- Failures are due to parts not being sold or approved by BreatheSafe.
- Failures arising from any other cause that is not directly related to a defect in material or workmanship.

This Express Warranty is VOID if the product is altered, modified, or used in the manner it was not designed for, also including unauthorized repairs, or using maintenance and repair parts other than those supplied by BreatheSafe.

### BreatheSafe responsibilities

If there is a defect in material or workmanship not caused by the excluded failures during the warranty period, BreatheSafe will either replace the defective goods at our Queensland factory, or designated branch. \*

Alternatively, BreatheSafe may elect to provide new replacement parts, BreatheSafe approved repair parts or assembled components needed to repair the defect. BreatheSafe reserves the right to provide a refund of the purchase price in lieu of replacement or repair at BreatheSafe's discretion. The replacement or repaired product will be sent to you freight prepaid by the customer or made available for pick-up on site.

### Users Responsibilities

The customer should ensure that the system is maintained according to BreatheSafe service requirements and only authorized parts must be used to service and maintain BreatheSafe systems. In the event of a suspected warranty claim, BreatheSafe should be contacted in the first instance to arrange the repair or to assist with diagnosis. Claims should be made within one week of the repair.

After contacting BreatheSafe, you may be required to deliver or send the parts to BreatheSafe's Queensland factory or designated branch. \* Link to online Warranty claim form <https://www.breathe-safe.com.au/warranty/>

### Exclusion and Limitations on Damages and Remedies

This warranty is provided in lieu of all other warranties, written or oral, whether expressed by affirmation, promise, description, drawing, model, or sample. To the extent allowed by law, all warranties other than this warranty, whether express or implied, including implied warranties of fitness for a particular purpose, are disclaimed. The maximum liability of BreatheSafe under this warranty shall not exceed the original purchase price of the product. Interference with the equipment by or abuse, or by operating the equipment at ambient temperatures or with electrical power characteristics outside the ranges indicated in our specification shall be excluded from this warranty, as shall consequential damages.

Excluded from any express warranty are costs incurred in relation to service outside our factory our designated service branch, including traveling time, waiting time, transport costs, mechanical and overtime payments required. As per Australian Consumer Law: You are entitled to choose a refund or replacement for major failures with goods. If a failure with the goods or service does not amount to a major failure, you are entitled to have the failure rectified in a reasonable time. If this is not done, you are entitled to a refund for the goods and to cancel the contract for the service and obtain a refund of any unused portion. You are also entitled to be compensated for any other reasonably foreseeable loss or damage from a failure in the goods or service.

**\*This express warranty gives you specific legal rights, and you may also have other rights that vary from country to country.**