

Kit Part Number: 701036

Breathe Safe

Part of **Aire Safe**

Parts and Service Manual

KOMATSU

WA900-3 WHEEL LOADER

HEPA H14 Variable Speed Pressuriser | INPRESS TS Cabin Display with CO2 Sensor | HEPA Return Air Filter

 +61 7 3276 7833

 www.breathe-safe.com.au

 sales@breathe-safe.com

 62 Mica Street, Carole Park, 4300, QLD

Controlled Document: M0447

Issue Date: 27/08/24

Revision: 1

INSTALLATION

CONTENTS

- Installation 1
- Safety..... 2
- Critical Parts & Maintenance Schedule 3
- Operator Guide 4
- Specifications - Pressuriser 5
- Parts List 6-8
- Technical Details 9-10
- Smoke Emitter Cabin Pressure Leak Test..... 11
- Cabin Sealing Test Pressure 12
- Commissioning Procedures 13
- Troubleshooting Guide 14
- User Settings Instructions 15-20
- Data Download..... 21-24
- Warranty..... 25

INSTALLATION OVERVIEW

Manufacturer	Komatsu
Type	Wheel Loader
Model	WA900-3
Cabin Pressure Max	
Set Auto Cabin Pressure	



HEPA H14 Variable Speed Pressuriser



INPRESS TS Cabin Display with Data Recorder



HEPA Return Air Filter

WARNING

THE PRESSURISATION SYSTEM DESCRIBED IN THIS MANUAL HAS THE FOLLOWING AREAS WHICH MAY BE DANGEROUS IF NOT TREATED WITH GREAT CARE.

QUALIFIED STAFF MUST WEAR THE CORRECT PERSONAL PROTECTIVE EQUIPMENT WHEN CLEANING AND SERVICING THIS UNIT DUE TO DUST AND FIBRES WHICH MAY BE CAUGHT BY THE STAGES OF AIR FILTRATION DURING NORMAL UNIT OPERATION.

THE ELECTRICAL POWER SYSTEM IS SUPPLIED BY 12V DC OR 24V DC AND NO WORK SHOULD BE CARRIED OUT ON THE PRESSURISER SYSTEM WITHOUT THE CORRECT SAFE WORK PROCEDURES AND ELECTRICAL SAFETY MEASURES BEING TAKEN, AND ALL RELEVANT CIRCUIT BREAKER OPENED TO ISOLATE THE CIRCUIT.

THE AIR FILTRATION SYSTEM MAY HAVE SEVERAL TYPES OF HIGH-SPEED ROTATING EQUIPMENT INSTALLED WITH VERY SHARP EDGES. ENSURE ALL SAFETY GUARD ARE IN PLACE WHILE THE SYSTEM IS RUNNING.

Please be aware that HEPA filters cannot be cleaned and must be replaced at the end of their lifecycle or if filter media has been damaged.



Hard Hat



Eye Protection



Dust Mask



Ear Protection



Protective Clothing

Particulate Behaviour

This is the length of time it takes for a particle to drop from a height of 1.5m in **STILL** air.



Warehouses and workshops do not have still air, so hazardous airborne particulates may remain in air for longer, increasing chance for workers to breathe in dust. Ensure PPE is worn when installing this system.



CRITICAL PARTS & MAINTENANCE SCHEDULE

Maintenance Schedule

The following tables show our suggested maintenance schedule for all units. Please note that site conditions may alter this.

Excludes high corrosion environments.

Data download is required to claim the 3-year warranty on Brushless Blower Motor.

Inspect every 500 Hours and replace when filter is full*

Component / System	Action Required
Turbo Pre-cleaner	Check operation of the Turbo Pre-Cleaner.
Pressuriser Blower	Ensure blower is operational.
HEPA Primary Filter p/n: 500000	Inspect filter capacity indicator. Replace HEPA filter when 80% or greater. Vacuum out housing before replacing the filter elements.
HEPA Return Air Filter P/N: 500014	Vacuum inside cabin floor before replacing filter.
Filter Frame Assembly, Mounts, Seals and Filter Housing	Check door seals, all bolts, screws, and all mounts are secure. Check the filter canister & ensure it is correctly fitted. Check latches are operational and in good order. Replace / Re-tension fixtures and fittings required.

15,000 Hours / 36 months*

Component / System	Action Required
500 Hour Inspection	All 500-hour inspection actions.
Pressuriser's Blower 200002	Replace BRUSHLESS Pressuriser blower.

Critical Parts				
Item	Part Number	Qty.	Description	Service Interval
1	500000	1	Fresh Air HEPA H14 Filter (Tested as per EN1822)	1000* Hours (>80% fan capacity)
2	500014	1	HEPA Return Air Filter	500* Hours
3	200002	1	Brushless Blower Motor – 24V	15,000 Hours
4	200027	1	BreatheSafe Digital Display – Data Recorder (INPRESS TS)	

*Filter service hours are subject to cab sealing efficiency, site conditions and correct system use.

Suggested Schedule Servicing*



Fan Capacity Indicator

The filter is serviceable if the motor capacity is between 10% & 80%. We recommend that the filter is changed if the capacity is over 80%.

*Site dependent

OPERATOR GUIDE

OPERATORS CHECKLIST

PRE-START

1. Visually inspect the BreatheSafe system for any damage.
2. Visually inspect the cabin for any damage to doors, windows, seals.
3. Please remove dust & debris from shoes and clothes before entering the cabin.
4. Ensure door(s) and windows are closed correctly.
5. Start engine and turn HVAC on to speed 2 (medium speed).
6. After fixed speed delay, the BreatheSafe display will show 50 Pascals or pre-set value.

The system is working correctly when the pascal value is green.
>> There is no further action required <<

NORMAL OPERATING CONDITION

Cab Air Conditioning

BreatheSafe recommends OEM air conditioning fan is set at mid speed or greater to circulate air around the breathing zone and minimise CO₂.

Acceptable operating range for BreatheSafe fan 10-80%. >80% recommend maintenance.

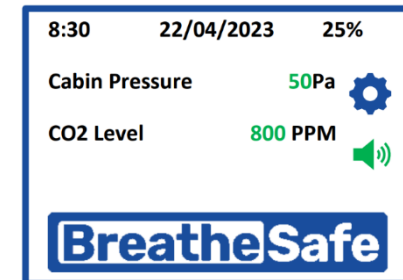

ALERTS

Fixed Fan Start Delay

- Allows the operator to carry out pre-start checks – limiting at 30% fan speed, press the red text to disable.

CO₂ Level Alert (if equipped)

- Ensure air conditioning fan is set at mid speed or greater to circulate air and minimise CO₂.

Low Pressure Alarm

- Cabin is not maintaining positive pressure – check doors and windows are closed correctly.
- Refer to maintenance department to check filters and cabin sealing. Ensure filters are serviceable.

Check Filter

- Reminder to inspect or replace filter. Service hour meter requires re-set.
- Refer to maintenance department.



Specifications High-Capacity HEPA Pressuriser

Blower	: Brushless Blower P/N 200002.
Protection	: Locked Rotor Protection (Sub Zero Environments) Under Voltage, Under/Over Current & Over Temperature.
Voltage	: 24VDC.
Current Draw	: 11 amps (peak). *Note: Motor has slow start to stop excessive in-rush current.
Air Flow	: Up to 30-300 m ³ /h or 50-215 CFM.
Pre-cleaner	: Integrated VLR (Very Low Restriction). Turbo Pre-Cleaner.
Filter Element	: BreatheSafe HEPA Primary Filter (H14=99.99% MPPS) TESTED AS PER EN1822 – P/N 500000.
Plugs & Fittings	: Mining Spec. Deutsch electrical plugs as standard.
Construction	: High strength composite construction.
Serviceability	: Easy access HEPA filter with twist-lock (TL) dust cap single assembly.
Mounting	: Heavy Duty adjustable mounting brackets.
Design	: Fully designed in SolidWorks 3D CAD & Ansys Engineering Simulation Software.
FEA Testing	: Critical components FEA (Finite Element Analyst) tested in Solid Works Simulation.
CFD Testing	: CFD (Computational Fluid Dynamics) simulations in Flow Works to ensure optimum air flow through the system.

SPECIFICATIONS HIGH-CAPACITY HEPA PRESSURISER

List of Abbreviations	
DH	Dual HEPA
DHPR	Dual HEPA Powered Recirculation
DHAC	Dual HEPA Activated Carbon
DHACPR	Dual HEPA Activated Carbon Powered Recirculation
CPM	Cabin Pressure Monitor
CPU	Central Processing Unit
DB	Decibel Sensor
DPM	Diesel Particulate Matter
GAS	Gas Sensor
HEPA	High-Efficiency Particulate Air Filter
HPAFU	High Pressure Air Filtration Unit
HRAF	HEPA Return Air Filter
HVAC	Heating Ventilation and Air Conditioning
MAF	Mass Air Flow
OEM	Original Equipment Manufacturer
PM	Particulate Mass
RH	Relative Humidity
TEMP	Temperature
TS	Touch screen
UI	User Interface
VMS	Vehicle Monitoring System
VS	Vibration Sensor
OGSP	OnGuard Sensor Pod
CO2s	CO2 Sensor INPRESS TS

Performance Specifications - Condenser	
Cooling Capacity	6.0 kW
Refrigerant	R134a
Total Refrigerant Charge	1.3kg +/- 100g

Item No.	Qty.	Description	Part No.
1	1	Pre-cleaner Hood & Rotor Assy	200004
2	4	Pre-cleaner Injector Ring	200005
3	1	TL Fan Blade (inc. in #7)	200006
4	1	TL Nose Cone / Pre-cleaner	200007
5	1	TL Motor Housing	200008
6	1	TL Filter Housing	200009
7	1	24v DC Brushless VSD Motor & TL Fan Blade	200002
8	1	O Ring Seal Kit 2 Parts	200010
9	1	Included in 8	200011
10	1	Wiring Sleeve	200012
11	1	HEPA H14 Filter	500000
12	3	M6 Nyloc Nut	300218 (M6NYL)
13	3	M6 x 55mm Hex Bolt	300982 (M655B)
14	4	M8 x 190 Hex Bolt	301136 (M8190B)
15	8	M8 x 22mm O/D HD Washer	300230 (M8222HTW)
16	4	M8 Nyloc Nut	300249 (M8NYL)
17	5	M4 x 75mm Pan Head Phillips Screw	300162 (M475PBH)

PARTS LIST – TL4 24V DC PRESSURISER UNIT

PRESSURISER ASSEMBLY No: 200000

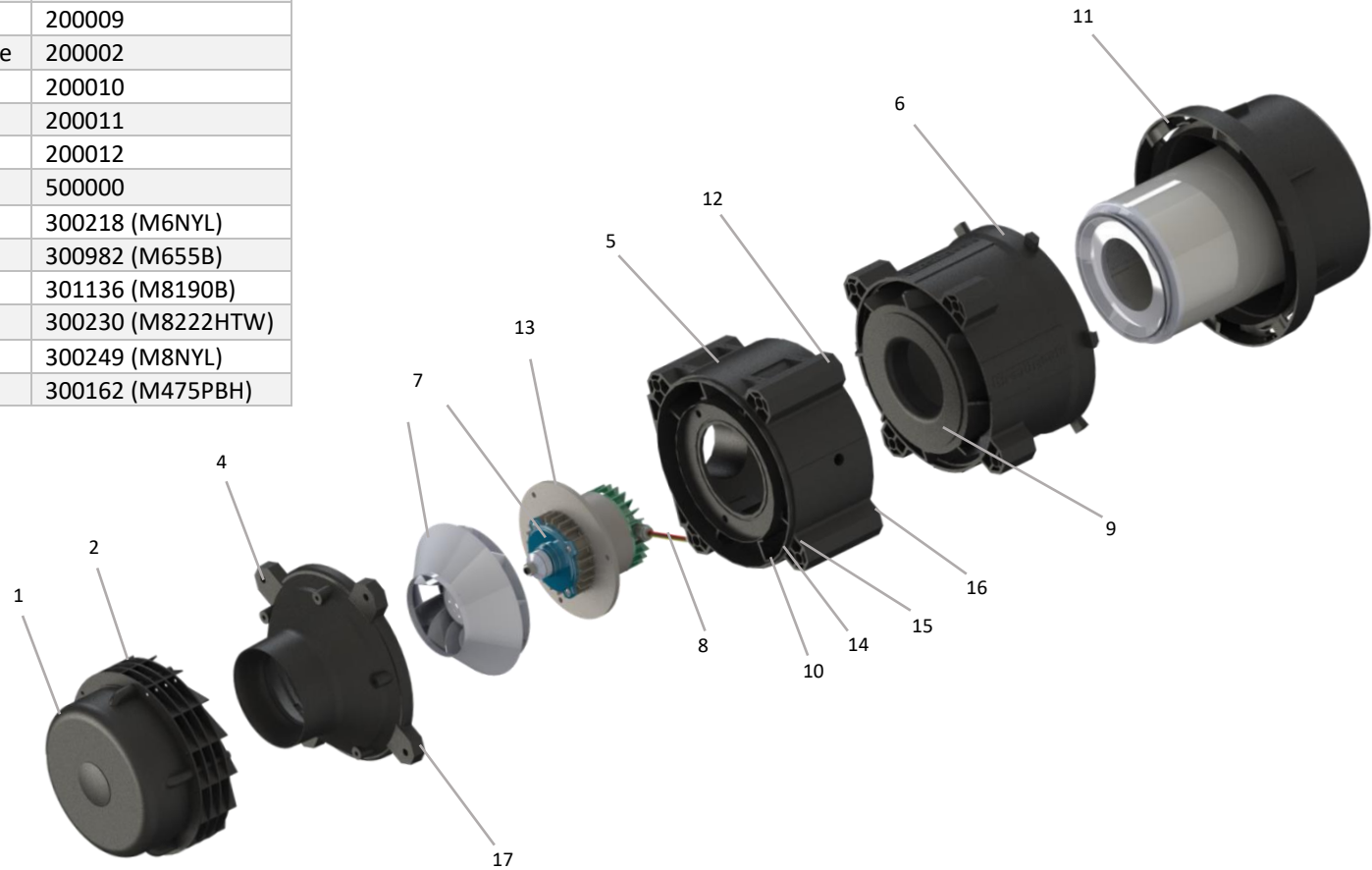

PARTS LIST – GA

Item No.	Part No.	Rev	Description	Qty	Colour	Group
1	TQM DP12590	1	Foxleigh Filter Cover General Assembly	1	Charcoal Grey MX83-682	-
2	TQM 08511	4	TL4 Side Mount Assembly	1	Charcoal Satin 27288351	Assembly
3	250101	[*]	Monitor Box, Large	1	(As Req'd)	Stock Item
4	200000	[*]	HPAFU 24VDC VSD TL4	1	-	Stock Item
5	500014	0	HEPA Filter 280 x 250 x 31	1	-	HEPA Filter

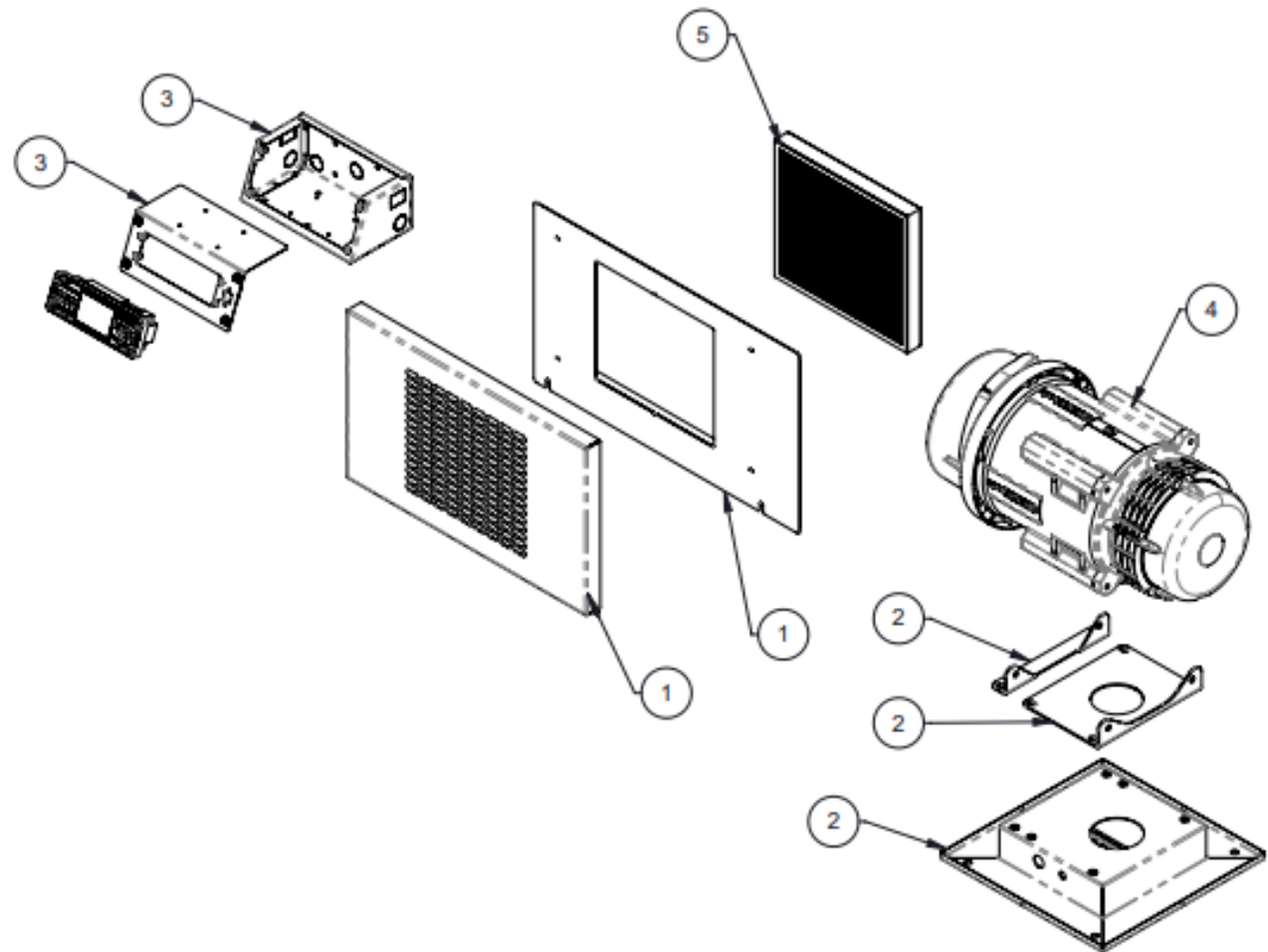

Item No.	Part No.	Rev	Description	Qty	Colour	Category
1	250101	[*]	STD Large Monitor Box	1	-	Stock Item
2	200027	N/A	INPRESS TS Controller CO2 Sensor	1	-	Stock Item
3	200031	N/A	CO2 Sensor Suit 200027	1	-	Stock Item

PARTS LIST – MONITOR MODULE

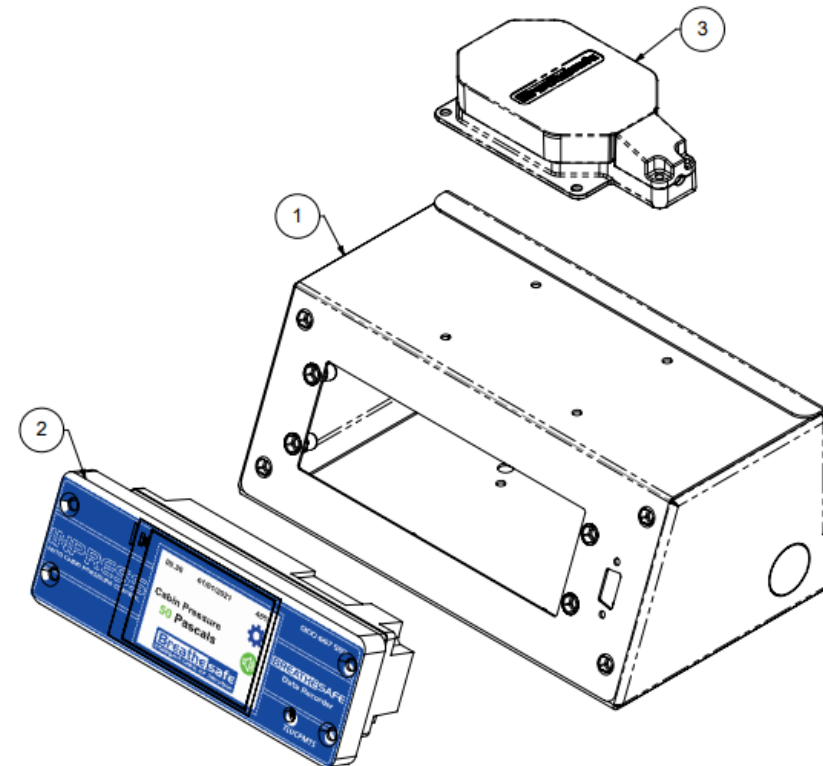

TECHNICAL DETAILS

Display Key Features

- Digital cabin pressure monitoring system
- Automatic cabin pressure control
- Intelligent fan speed output
- Data logger
- Alarm for low-pressure (RS20)
- Light sensor for automatic dimming of the screen

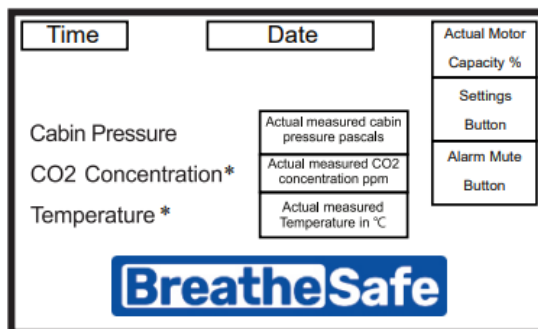
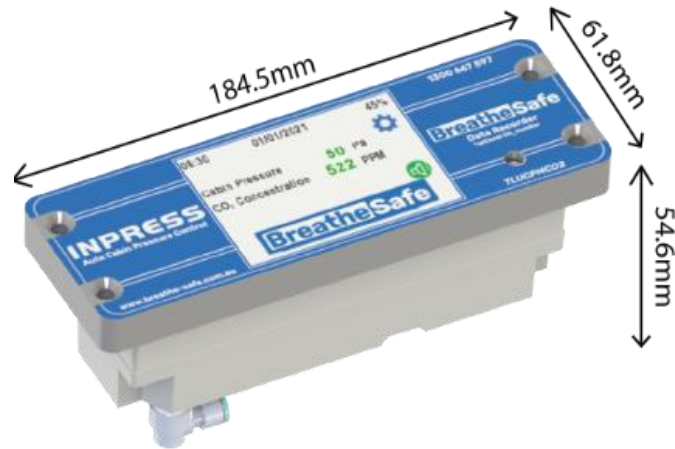

MAIN SCREEN

Options* when fitted

CO2 Sensor

- CO2 Sensor Type is NDIR (Non-Dispersive Infrared)
- Sample Rate is every 2 seconds
- 12-30V DC Operating Voltage
- Automatic Altitude Compensation
- Alarm Set points are adjustable
- No setup required



Connections: 200027

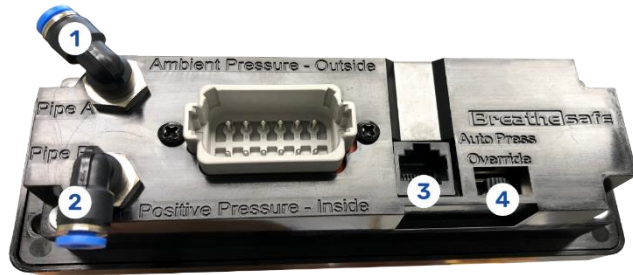

Item	Destination
1	PIPE A – AMBIENT PRESSURE – OUTSIDE
2	PIPE P – POSITIVE PRESSURE – INSIDE
3	RJ45 CONNECTOR – CO2 SENSOR
4	OVERRIDE TOGGLE SW = MAX SPEED

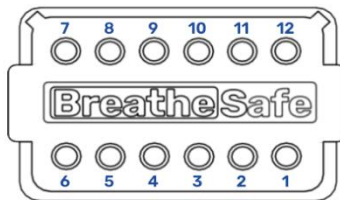

Item	Destination
1	12/24 VOLT POSITIVE SUPPLY
2	CAN H OPTION
3	CAN L OPTION
4	SERIAL TRANSMIT RS232
5	MOTOR CONTROL VOLTS OUT
6	ALARM + OUTPUT
7	TEMP SENSOR
8	NO CONNECTION
9	SERIAL RECEIVE RS232
10	DOOR INPUT (+)
11	WINDOW INPUT (+)
12	0V NEGATIVE GROUND

Wiring Diagram

INPRESS User Interface (UI)

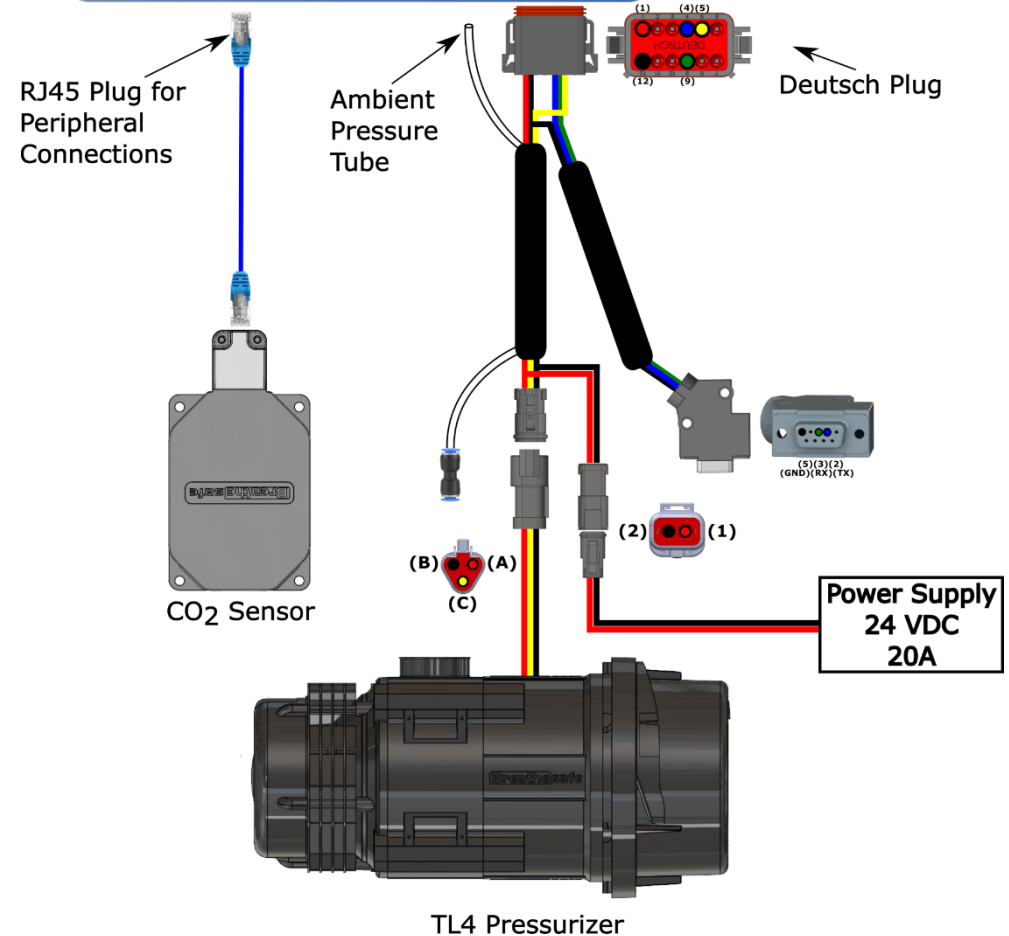
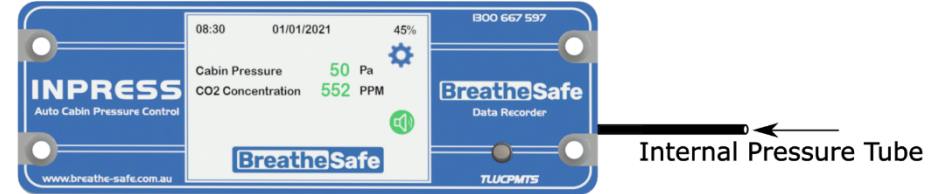

TECHNICAL DETAILS

















* Do not handle until MSDS & all safety precautions have been read and understood. Use personal protective equipment as required.

Before use, carefully read the product label. Safe work practices are advised to avoid eye or skin contact and inhalation. Observe good personal hygiene, including washing hands before eating. Prohibit eating, drinking, and smoking in contaminated areas. Avoid inhalation. Mechanical extraction ventilation is recommended when the removal of atmospheric contaminants is required. Maintain dust / fume levels below the recommended exposure standard. For small amounts, absorb with sand, vermiculite or similar and dispose of at an approved landfill site.

WARNING	
For Professional Use Only – keep out of reach of children.	
Do not ignite near or around flammable materials.	
Use only in well-ventilated areas, outdoors, and/or with proper respiratory protection.	
Persons with respiratory sensitivity should avoid exposure to any smoke.	
Concentrated smoke may cause severe burns to the skin, eyes, or respiratory system.	
Improper use may result in sufficient inhalation of smoke to cause respiratory tract irritation and lung damage.	
Harmful if swallowed.	
DANGER	
Use only as directed. Do not handle until all safety precautions, including Safety Data Sheet, have been read and understood. The product contains hexachloroethane. Wear protective clothing. If exposed or concerned, get medical advice. Store in a cool, dry, secure location. KEEP OUT OF REACH OF CHILDREN. Dispose of contents/container per location regulations. When used as directed, exposure should be limited and usually poses no hazard because the hexachloroethane is consumed inside the tube as smoke is produced.	
Directions: (Smoke Bomb)	
1	Ensure other workers in close proximity are informed of use. Place on a non-combustible container, away from flammable materials.
2	Place at Blower intake, or upwind of target area, or near centre of space.
3	Orient "Smoke Issues Here" toward air stream, away from surfaces. Place candle on a flame / heat resistance plate – if not it will melt into the plastic surface.
4	Ensure smoke will not create any hazard where it is anticipated to go.
5	Ignite emitter inside the cabin using site approved device i.e., solder torch or 'lighter' and conduct smoke test.
6	Do not touch or hold smoke generator after ignition – item becomes very hot & remains hot after use.
Smoke Emitter Cabin Pressure Leak Test	
1	The pressuriser system is switched on (TEST MODE).
2	Hold the smoke emitter angled down.
3	Ignite emitter using site approved ignitor i.e., solder torch or 'lighter'.
4	When the product ignites, remove the lighter.
5	If the product flames up, blow out the flame.
6	Place the emitter in a non-flammable container and place it inside the cabin at floor level and close the door/windows.
7	Observe smoke leaks to indicate worn-out or broken seal locations. Check leakage points outside the cabin.
8	Do not come into contact with or inhale smoke haze.
9	Wait until the smoke haze completely disperses before re-entering the cabin. Open door to allow sufficient ventilation of smoke prior to entering cabin.

SMOKE EMITTER CABIN PRESSURE LEAK TEST

Link to MSDS: [SMOKE GENERATOR TQ7621AT30S.pdf](#)

Personal Protective Equipment (PPE)	
	Safety glasses must be worn at all times.
	Sturdy footwear with rubber soles must be worn.
	Respiratory protection devices may be required.
	Gloves may be worn.
Pre-Operational Safety Checks	
	Locate and ensure you are familiar with all machine operations and controls.
	Check work area and walkways to ensure no slip/trip hazards are present.
	Ensure the work area is clean and clear of any flammable material & fire extinguish device is present.
Operational Safety Checks	
	Ensure the machine is correctly isolated / immobilized.
	Ensure other persons do not inhale smoke haze.
	Take care and do not place a lit emitter close to a flammable surface.
Ending Operations and Cleaning Up	
	Leave the work area in a safe, clean, and tidy state.
Potential Hazards	
	Falls
	Fumes
	Fire
	May cause cancer
Exposure is highly unlikely when the product is used as directed. Direct contact with the product does not occur.	
Don't	
	Do not use if an open flame is forbidden.
	Never leave the emitter [cabin test] unattended.

*This SWP does not necessarily cover all possible hazards associated with this equipment and should be used in conjunction with other references. It is designed as a guide to be used to compliment training and as a reminder to users prior to equipment use.

CABIN SEALING TEST PROCEDURE

Cabin Sealing Efficiency Test Procedure

1	Start Engine – Pressuriser System is ON
2	Ensure all windows & door(s) are CLOSED correctly (no cabin pressure leaks) NOTE: for a new cabin with effective seals, you may need to open a window slightly before closing the door to bleed the static cabin air pressure outwards. Once door is fully closed then close windows to begin testing.
3	Enter the Settings menu via the touch screen button.
4	Select and press the System Check button to go to System Test – Max Fan.
5	Record / photograph the maximum cabin pressure achieved.

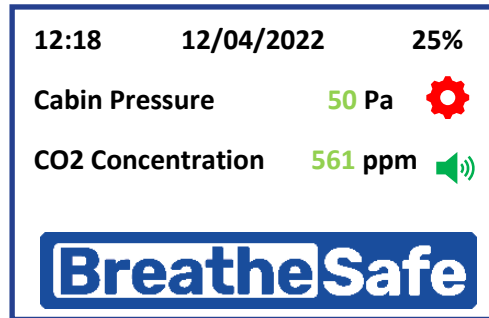

Press Settings.

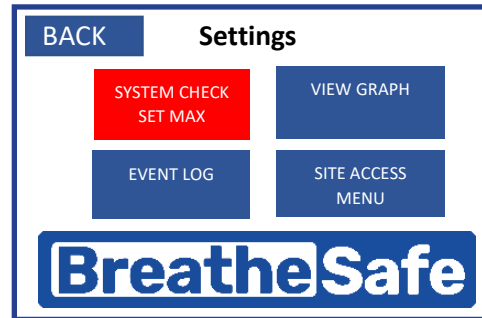

Press “System Check – Set Max” box.

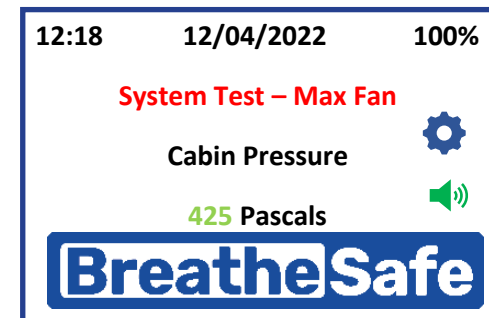

Record / Photograph the cabin pressure result (Max Fan Speed).

Commissioning Procedures

COMMISSIONING PROCEDURES – CABIN PRESSURISER

Follow each step of the installation guide that was supplied with the BreatheSafe kit.

Cabin sealing is an integral part of RS20 & ISO 23875; you must ensure that cabin seals are adequate for maintaining positive pressure. In addition, the site (end-user) must have the correct procedure(s) for servicing OPERATOR enclosure seals in a proactive manner rather than reactive. Items such as door and window seals must be in good working order or new seals FITTED before the BreatheSafe system installation.

Touch-screen cabin pressure display/controller Part# 200027:

***System Check Function:** enter the Settings menu option and select “System Check – Set Max.” The minimum BreatheSafe requirement for cabin sealing efficiency is 250 pascals; if this result is not met, it is essential to re-examine and find pressure leaks of the enclosure and apply new sealing measures.

Submission for commissioning procedure as per the diagram below:

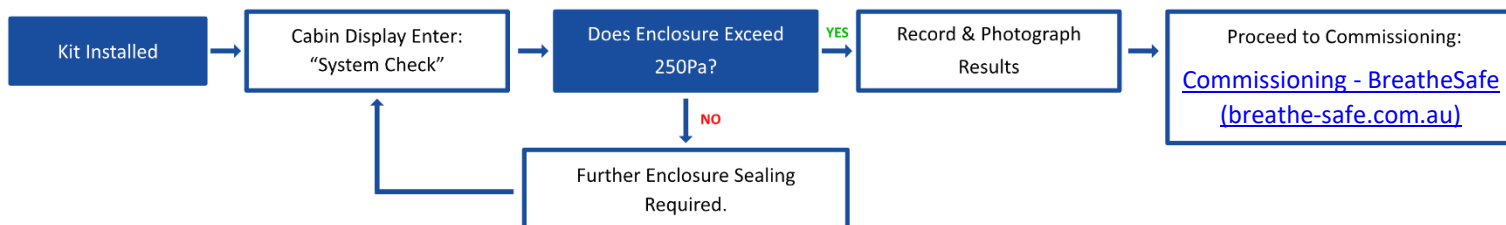

The commissioning images required are:

- ID plate / Machine Serial Number / Asset Number or Call Sign
- INPRESS TL Pressuriser location
- HEPA Return Air Filter Location Option: Powered Return Air Filter
- Cabin Pressure Display Location – Including the “System Check” maximum cabin pressure result with motor output capacity %

Fill in the BreatheSafe Service Tag with the following details:

- Machine Serial Number and Installers details
- Date installed and System Check result (max cabin pressure)
- The set cabin pressure with actual pressure and motor percentage output
- Verify the 250-pascal threshold was achieved = pass OR not achieved = fail**

Please upload machine and installation details in conjunction with the required images. A Commissioning Certificate will be sent to the email address you nominate. **Extended warranty for (RS20 & ISO 23875) BreatheSafe Systems is only applicable to operator enclosures meeting this requirement.

BREATHESAFE SYSTEM TROUBLE SHOOTING GUIDE *TOUCH CONTROL		
FAULT	POSSIBLE CAUSE	SOLUTION
*ERR error code	Poor sensor connection	Remove & refit pod connection cable
	Corrupted coding	Contact support for default reset pin
*Check filter alarm	Service hour timeout	Access Check Runtime menu - reset hours via 7597 code
Temperature / CO2 error	Sensor not connected	Fit sensor or disable via site access CO2 & or temperature menu
Pressuriser running at full speed/noisy	Filter blocked	Service filter
	Door or window open	Ensure doors & windows securely shut
	Cabin sealing capacity not adequate	Perform pressure test procedure & seal leak points as required
	Sense pipe blocked	Ensure clear & not bent
	Internal sensor damaged	Replace controller **No need to change setpoint
Filter blocking quickly	Defective cabin sealing	Perform pressure test procedure & seal leak points as required
	Pre-cleaner failed	Check operation & replace if necessary
Display blank	Poor power supply	Check mains supply fuse & correct voltage
		Check voltage & 20AMP supply/connections at pin 1 @ monitor
		Check earth continuity at controller pin 12
	Failed controller	Replace monitor
Controller showing 0.0 pressure	Fresh air filter blocked	Check filter condition & replace if required.
Low pressure alarm	Door or window open	Ensure doors & windows securely shut
	Cabin sealing capacity not adequate	Perform pressure test procedure & rectify cab sealing
	Pressuriser not operating	Ensure correct voltage 12v or 24v to pressuriser motor pin A
		Check 1.6V - 10V present at motor Pin C
		Check 20A Supply fuse
		Check earth continuity Pin B
Pressure sense tube blocked	Unplug at monitor & ensure clear flow to external of cabin	
	Ensure pressure tube fitted correct port A	
	**No need to change setpoint	
Pressuriser not working	Poor power supply	Check 20A mains fuse & correct voltage
		Ensure adequate wire size & no voltage drop
		Ensure correct voltage 12v or 24v to pressuriser motor pin A
		Check 1.6V - 10V present at motor Pin C
	Poor earth	Check earth continuity @ motor pin B
Motor faulty	Replace TL4M	
Access Codes:	Site Access: 7597	Contact Support for Factory Setup Pin

User Settings Instructions

ENTER SET UP MODE

Start-Up Screen > Main Screen > Settings Button > Settings Screen > Site Access Button > Insert Pin > Site Menu

To enter the Setup mode, press the SETTING button.

Then enter SITE ACCESS MENU. Type in 4-number pin and press ENTER.

Insert Pin = 7597

Enter Pin

1	2	3
4	5	6
7	8	9
CLEAR	0	ENTER

7597

SET UP PARAMETERS

Placing the BreatheSafe 200027 unit into Setup mode allows the adjustment of the following parameters:

- Time (hours/minutes/seconds)
- Date (day/month/year)
- Pressure alarm setpoint
- Preferred cabin pressure
- Alarm delay/ intervals of alarm
- Calibration and system settings
- Resetting of the data logging
- Service reminders interval gap
- Reset current runtime between services
- CO2 settings and alarms

USER SETTINGS INSTRUCTIONS

Settings

SYSTEM CHECK	VIEW GRAPH
EVENT LOG	SITE ACCESS MENU

BreatheSafe

Settings Page 1

STARTUP OPTIONS	DOOR WINDOW SETTING	PRESSURE SETPOINT
CHECK RUNTIME	DATE / TIME	CO2 SETTING

BreatheSafe

Settings Page 2

ALARM MUTE RESET	ZERO SENSOR	TEMP SETTING
BUZZER SETTINGS	LOG SETTINGS	FACTORY SETUP

BreatheSafe

PRESSURE SETPOINT

The pressure setpoint changes the pressure that the cabin will be maintained. INPRESS TS maintains the pre-set pressure within the cabin compared to outside.

Enter Setup mode and select ADJUST SETPOINT button. Then, use the onscreen UP and DOWN buttons to change the corresponding fields.

1 Main dashboard showing Cabin Pressure 50Pa, CO2 Level 200 PPM, and Temperature 20°C.

2 Settings menu with options: SYSTEM CHECK, VIEW GRAPH, EVENT LOG, and SITE ACCESS MENU.

3 Enter Pin screen with PIN 7597.

4 Settings Page 1 with options: STARTUP OPTIONS, DOOR WINDOW SETTING, PRESSURE SETPOINT, CHECK RUNTIME, DATE / TIME, and CO2 SETTING.

5 Pressure Settings screen with fields: Alarm Set Point (20), Pressure Set Point (50), and Pressure Alarm Delay (5 mins).

PRESSURE ALARM SETTING

USER SETTINGS INSTRUCTIONS

The mining industry benchmark for cabin pressure is 50 pascals and low-pressure is set at 20 pascals.

After a delay the alarm will activate if cabin pressure remains below the pre-set value. Enter Setup mode and select ADJUST SETPOINT button. Then, use the onscreen UP and DOWN buttons to change the corresponding fields.

1 Main dashboard showing Cabin Pressure 50Pa, CO2 Level 200 PPM, and Temperature 20°C.

2 Settings menu with options: SYSTEM CHECK, VIEW GRAPH, EVENT LOG, and SITE ACCESS MENU.

3 Enter Pin screen with PIN 7597.

4 Settings Page 1 with options: STARTUP OPTIONS, DOOR WINDOW SETTING, PRESSURE SETPOINT, CHECK RUNTIME, DATE / TIME, and CO2 SETTING.

5 Pressure Settings screen with fields: Alarm Set Point (20), Pressure Set Point (50), and Pressure Alarm Delay (5 mins).

SERVICE INTERVAL

Use the onscreen UP and DOWN buttons to change the service interval setpoint.

To reset the current runtime to zero, press the RESET CURRENT RUNTIME button and enter the site access pin.

The screenshots show the following steps:

- 1**: Main dashboard showing Cabin Pressure (50Pa), CO2 Level (200 PPM), and Temperature (20°C).
- 2**: Settings menu with 'SITE ACCESS MENU' highlighted in red.
- 3**: 'Enter Pin' screen with a numeric keypad and the pin '7597' entered.
- 4**: 'Settings Page 1' menu with 'CHECK RUNTIME' highlighted in red.
- 5**: 'Pressure Settings' screen showing 'CURRENT RUNTIME' at 700 and 'SET SERVICE INTERVAL' at 1000.

DATE & TIME SETTINGS

Change the recorded date displayed and measured by the INPRESS TS.

USER SETTINGS INSTRUCTIONS

The screenshots show the following steps:

- 1**: Main dashboard showing Cabin Pressure (50Pa), CO2 Level (200 PPM), and Temperature (20°C).
- 2**: Settings menu with 'SITE ACCESS MENU' highlighted in red.
- 3**: 'Enter Pin' screen with a numeric keypad and the pin '7597' entered.
- 4**: 'Settings Page 1' menu with 'DATE / TIME' highlighted in red.
- 5**: 'Date/Time Settings' screen showing the date '04 / 22 / 2023' and time '4 : 10'.

PRESSURE ALARM BUZZER SETTING

To disable the buzzer, toggle through to the ENABLED and DISABLED buttons.

1 Main dashboard showing Cabin Pressure (50Pa), CO2 Level (200 PPM), and Temperature (20°C).

2 Settings menu with 'SITE ACCESS MENU' highlighted.

3 Enter Pin screen with '7597' entered.

4 Settings Page 1 with 'PRESSURE SETPOINT' highlighted.

5 Settings Page 2 with 'BUZZER SETTINGS' highlighted.

6 Alarm Buzzer Settings screen with 'ENABLED' highlighted for the Pressure Buzzer.

CALIBRATE ZERO SENSOR

Over long runtime, the 200027 may need recalibration. This screen allows the sensor to be recalibrated if more than 5 Pascals are out. To recalibrate, open windows and doors, turn off air conditioning, and any other device that may alter cabin pressure. Then, press the AUTO ZERO SENSOR button and leave the cabin while measuring. This process will reset the Zero Pressure.

ALARM BUZZER SETTINGS

1 Main dashboard showing Cabin Pressure (50Pa), CO2 Level (200 PPM), and Temperature (20°C).

2 Settings menu with 'SITE ACCESS MENU' highlighted.

3 Enter Pin screen with '7597' entered.

4 Settings Page 1 with 'PRESSURE SETPOINT' highlighted.

5 Settings Page 2 with 'ZERO SENSOR' highlighted.

6 Zero Sensor Adjustment screen with 'AUTO ZERO SENSOR' button highlighted.

CO2 MODULE ENABLE/DISABLE

Enable or disable to CO2 module used for measuring CO2 levels within the cabin.

1 Main Dashboard: 8:30, 22/04/23, 25%. Cabin Pressure: 50Pa. CO2 Level: 200 PPM. Temperature: 20°C.

2 Settings: BACK, Settings, SYSTEM CHECK, VIEW GRAPH, EVENT LOG, SITE ACCESS MENU.

3 Enter Pin: BACK, Enter Pin, PIN: 7597, 1-9, CLEAR, 0, ENTER.

4 Settings Page 1: BACK, Settings Page 1, NEXT, STARTUP OPTIONS, DOOR WINDOW SETTING, PRESSURE SETPOINT, CHECK RUNTIME, DATE / TIME, CO2 SETTING.

5 CO2 Sensor Alarm Setting: BACK, CO2 Sensor Alarm Setting, DISABLE CO2 SENSOR. CO2 ALARM DELAY SETTING: 2 Min. CO2 PRIMARY ALARM SETPOINT: 1000 PPM. CO2 CRITICAL ALARM SETPOINT: 2500 PPM. ALARM MUTE DELAY.

CO2 PRIMARY ALARM POINT

The first alarm will sound when CO2 levels inside the enclosure reach this point.

CO2 SETTINGS

1 Main Dashboard: 8:30, 22/04/23, 25%. Cabin Pressure: 50Pa. CO2 Level: 200 PPM. Temperature: 20°C.

2 Settings: BACK, Settings, SYSTEM CHECK, VIEW GRAPH, EVENT LOG, SITE ACCESS MENU.

3 Enter Pin: BACK, Enter Pin, PIN: 7597, 1-9, CLEAR, 0, ENTER.

4 Settings Page 1: BACK, Settings Page 1, NEXT, STARTUP OPTIONS, DOOR WINDOW SETTING, PRESSURE SETPOINT, CHECK RUNTIME, DATE / TIME, CO2 SETTING.

5 CO2 Sensor Alarm Setting: BACK, CO2 Sensor Alarm Setting, DISABLE CO2 SENSOR. CO2 ALARM DELAY SETTING: 2 Min. CO2 PRIMARY ALARM SETPOINT: 1000 PPM. CO2 CRITICAL ALARM SETPOINT: 2500 PPM. ALARM MUTE DELAY.

CO2 ALARM DELAY

After CO2 (concentration in ppm) within the cabin reaches the 1000 ppm setpoint, the alarm will sound after this designated amount of time. The Alarm Delay adjusts the time between the INPRESS TS measuring CO2 concentration and sounding the alarm. Use the onscreen ADJUST buttons to change the corresponding fields. For example, press to toggle through Disabled / 1 – 10 minutes.

1 Main Dashboard: 8:30, 22/04/23, 25%. Cabin Pressure: 50Pa. CO2 Level: 200 PPM. Temperature: 20°C.

2 Settings Menu: BACK, Settings, SYSTEM CHECK, VIEW GRAPH, EVENT LOG, SITE ACCESS MENU.

3 Enter Pin: BACK, Enter Pin, PIN: 7597.

4 Settings Page 1: BACK, Settings Page 1, NEXT, STARTUP OPTIONS, DOOR WINDOW SETTING, PRESSURE SETPOINT, CHECK RUNTIME, DATE / TIME, CO2 SETTING.

5 CO2 Sensor Alarm Setting: BACK, CO2 Sensor Alarm Setting, DISABLE CO2 SENSOR, CO2 ALARM DELAY SETTING: 2 Min, CO2 PRIMARY ALARM SETPOINT: 1000 PPM, CO2 CRITICAL ALARM SETPOINT: 2500 PPM.

6 CO2 Sensor Alarm Setting: BACK, CO2 Sensor Alarm Setting, DISABLE CO2 SENSOR, CO2 ALARM DELAY SETTING: 2 Min, CO2 PRIMARY ALARM SETPOINT: 1000 PPM, CO2 CRITICAL ALARM SETPOINT: 2500 PPM, ALARM MUTE DELAY.

CO2 CRITICAL ALARM MUTE RESET

The critical alarm is set at 2500 PPM and cannot be changed. The mute delay, however, can be configured.

CO2 SETTINGS

1 Main Dashboard: 8:30, 22/04/23, 25%. Cabin Pressure: 50Pa. CO2 Level: 200 PPM. Temperature: 20°C.

2 Settings Menu: BACK, Settings, SYSTEM CHECK, VIEW GRAPH, EVENT LOG, SITE ACCESS MENU.

3 Enter Pin: BACK, Enter Pin, PIN: 7597.

4 Settings Page 1: BACK, Settings Page 1, NEXT, STARTUP OPTIONS, DOOR WINDOW SETTING, PRESSURE SETPOINT, CHECK RUNTIME, DATE / TIME, CO2 SETTING.

5 CO2 Sensor Alarm Setting: BACK, CO2 Sensor Alarm Setting, DISABLE CO2 SENSOR, CO2 ALARM DELAY SETTING: 2 Min, CO2 PRIMARY ALARM SETPOINT: 1000 PPM, CO2 CRITICAL ALARM SETPOINT: 2500 PPM.

6 Critical Alarm Mute Timeout Adjustment: BACK, Critical Alarm Mute Timeout Adjustment, SET MUTE TIMEOUT MINUTES: 10 Mins.

Data Download – Setting up RS232 Connection



- 1 Plug the RS232/USB adaptor into a free USB port on your computer.
- 2 Open up TeraTerm software.
(TeraTerm is an open-source software tool and easily accessible via online search)
- 3 Use the following settings in TeraTerm: Serial and choose the correct port connection.

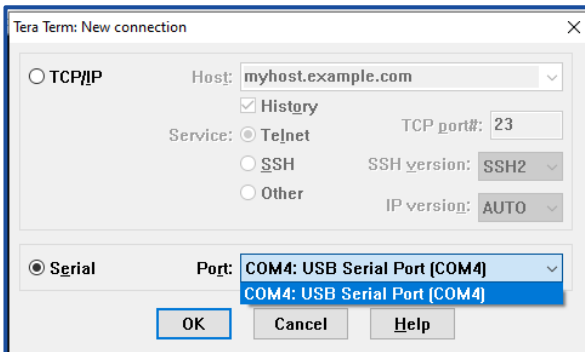

Hint:
Click on the COMxx Port with the “USB serial Port” connection from the drop-down menu.

Example:
COM 4
This connection may be different on your computer.

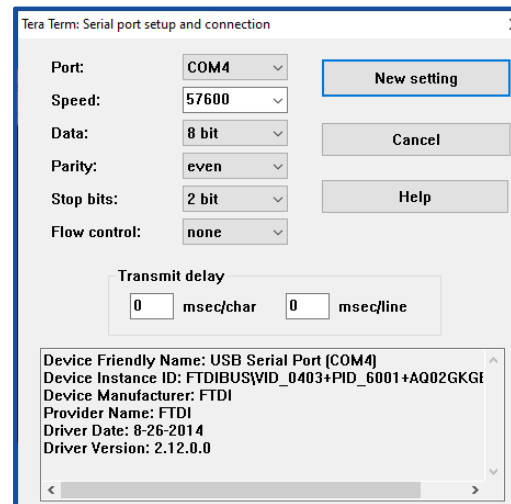
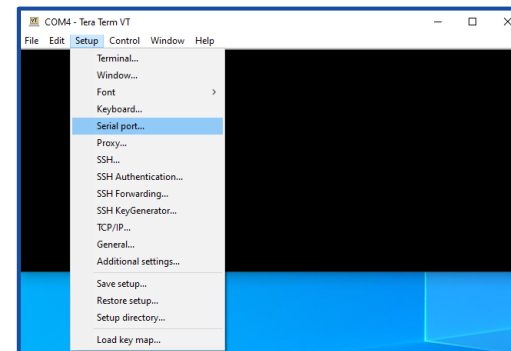
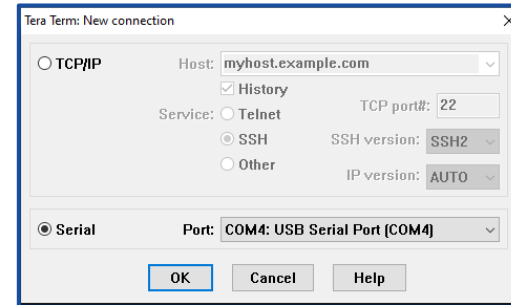

DATA DOWNLOAD

- 4 Click OK once the correct communication port has been identified.
- 5 Go to SETUP and click on Serial Port.
- 6 Change the COM ports to the following configuration:

Baud

Rate: 57600 Data: 8 bit

Parity: EVEN

Stop: 2 bit

Flow Control: NONE

DATA DOWNLOAD

Data Download – Setting up RS232 Connection

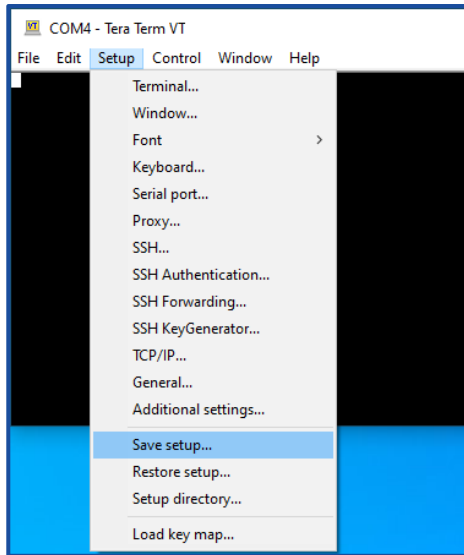

- 7 If required, you may choose to save the COM port settings. Go to Settings and click save the setup.

Hint: From the drop-down menu, click on the Save Setup.

Name the file and save it.

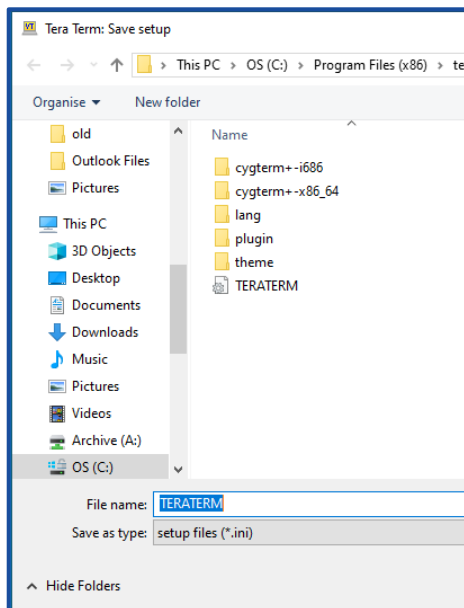

- 8 The next time a download is required, you may restore the setup, and the required COM PORT settings will be loaded, ready to download the data file from the 200027 unit.

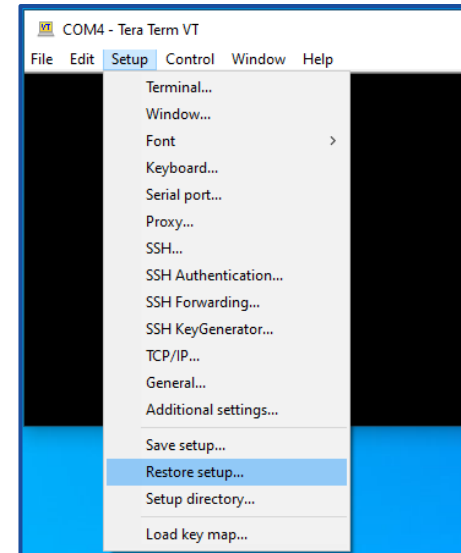

- 9 From the drop-down menu, click on Restore setup.

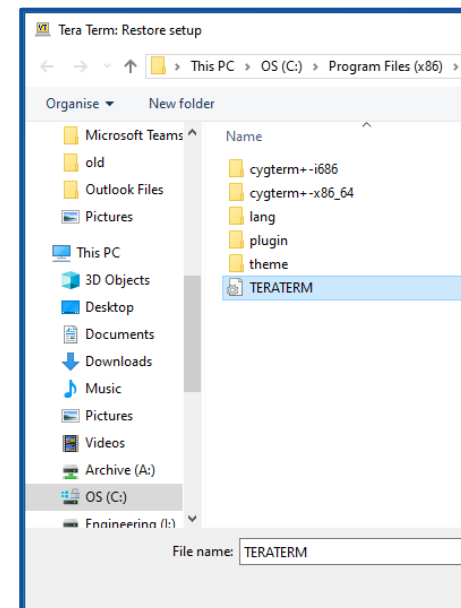

- 10 Choose the file name you have already saved.

INPRESS Controller Set Up

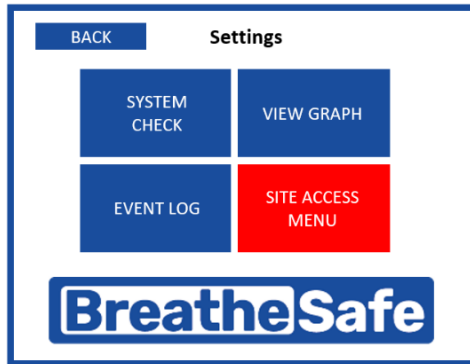

1. Press 'SITE ACCESS MENU'.

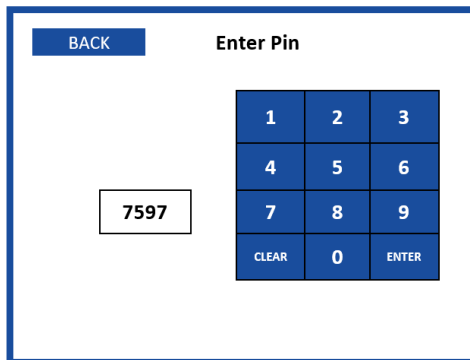

2. Enter the access pin '7597'.

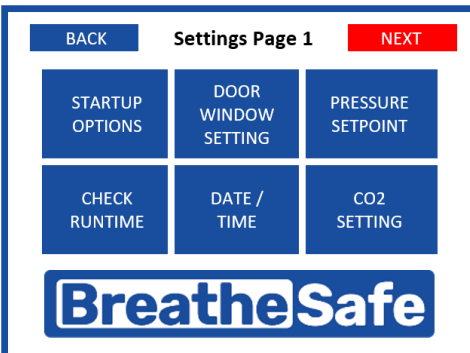

3. Press 'NEXT'.

CONTROLLER SET UP

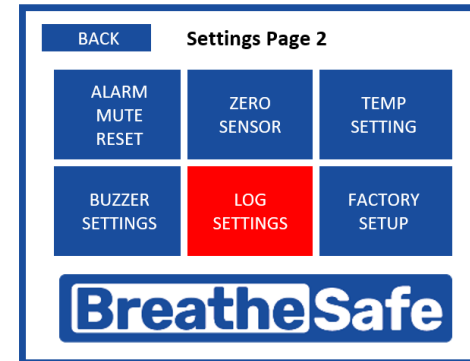

4. Press 'LOG SETTINGS'.

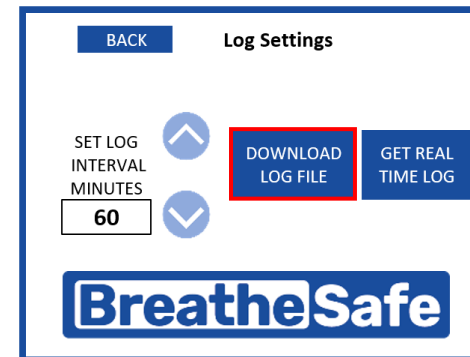

5. Press 'DOWNLOAD LOG FILE'.

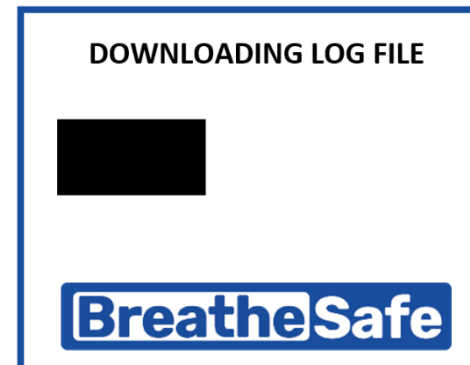

6. Data is now downloading from controller to terminal open on the computer (TeraTerm in this example).

DATA DOWNLOAD

Data Download – Copying Contents from Terminal to Spreadsheet

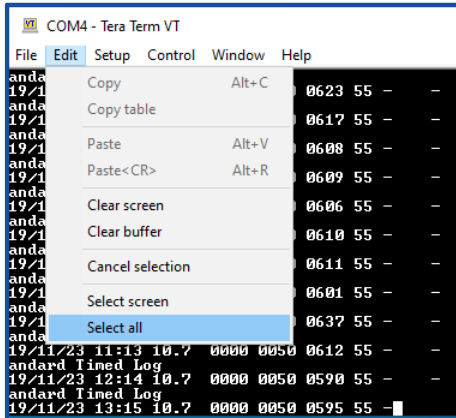

12 From the drop-down menu, click on the Edit menu function.

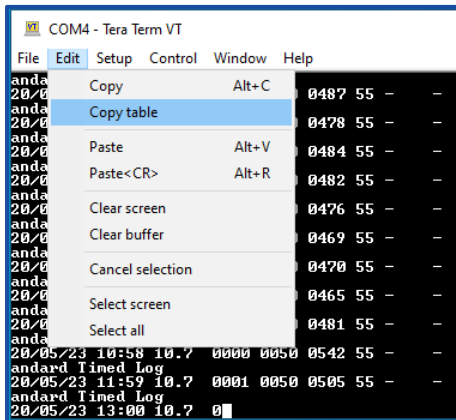

13 Press "Select All".

14 Select "Copy table".

15 Open a blank excel document and click on the page. Then, right-click to paste the copied table.

16 Fields are:

Date, time, motor (volts) output (e.g. 5.5 = 55%), cabin pressure (Pa), cabin pressure pre-set (Pa), CO2 sensor.

Excel Data Instructions – Unformatted

Open an Excel sheet and select the first cell A-1. Next, press and hold down the CTRL button on your keyboard and then press the letter V on the keyboard.

This procedure will paste the copied data onto that Excel sheet. Once that data has been pasted onto the Excel sheet, click on 'DATA' on the pull-down menu, followed by 'Text to Columns'. Next, select 'Delimited' on the newly opened window and click on Next.

Only select the 'Comma' button in the next window and then click 'Finish'. Then, the Excel fields will update such that each piece of data is placed in the correct columns.

The data is now ready for archiving.

Data Logging Formats

BU No: xxxxxx (the device number unique to each unit and used for identification – format = 000000)

Time: [09:25]

Date: [25/07/12]

Pressure: 32 (Pascals) as an example.

	A	B	C	D	E	F
1	DATE	TIME	MOTOR (VOLT) OUTPUT	CABIN PRESSURE PA	CABIN PRESET PA	CO2 Sensor
2	12/11/2023	16:43	2.1	50	50	600
3	12/11/2023	17:44	2.1	50	50	596
4	12/11/2023	18:46	2.1	51	50	601
5	12/11/2023	19:47	2.1	50	50	603
6	12/11/2023	20:48	2.1	50	50	595
7	12/11/2023	21:50	2.1	50	50	593
8	12/11/2023	22:51	2.1	50	50	591
9	12/11/2023	23:52	2.1	50	50	588
10	13/11/2023	0:54	2.1	51	50	595
11	13/11/2023	1:55	2.1	50	50	582
12	13/11/2023	2:56	2.1	50	50	587
13	13/11/2023	3:58	2.1	51	50	593
14	13/11/2023	4:59	2.1	50	50	598
15	13/11/2023	6:00	2.1	51	50	742
16	13/11/2023	7:02	2.1	51	50	767

Alarm Type	
0	= No alarm
1	= Low-pressure alarm
2	= Window open
3	= Door open

INPRESS TL WARRANTY

Express Warranty

All BreatheSafe products carry a warranty against defects in materials or workmanship, provided the defects are not from factors outside of BreatheSafe's control (including neglect, lack of maintenance, improper installation or operation, unauthorized servicing repair, etc.). BreatheSafe will replace goods defected in material or workmanship at our Queensland factory or designated branch*. All parts deemed as failed or faulty must be returned to BreatheSafe for evaluation unless otherwise stated in writing.

Note- Systems must be installed and commissioned as per BreatheSafe installation and commissioning instructions. Once commissioned, the online commissioning sheet must be filled in, extending the components warranty as below. In addition, the system must be serviced and maintained correctly and by trained and qualified personnel. This requisite includes BreatheSafe technicians, qualified automotive air-conditioning technicians, or qualified auto electricians.

Warranty period – Standard

- 1 year or 10,000 hours (whichever occurs first).
- Controllers – 1 year no extended warranty option.
- Warranty Period Extension when commissioning documents are registered online within 28 days of installation
- Extended warranty** only offered if commissioning maximum pressure test reaches at least 250Pa.
- Brushless motor fixed speed two years, or 10,000 hours (whichever occurs first).
- Variable speed brushless motor 15,000 hours, or 3 years** (whichever occurs first).

Must be supplied with a variable speed pressure controller, data download required for 3-year warranty option. Link to online Commissioning and Extended Warranty Registration form <https://www.breathe-safe.com.au/commission/>

What is not covered under Express Warranty?

- Failures are due to incorrect application.
- Damage resulting from neglect, misuse, lack of maintenance, improper installation, or operation, inappropriate or abnormal use, accidental or unauthorized servicing repair.
- Failures are due to parts not being sold or approved by BreatheSafe.
- Failures arising from any other cause that is not directly related to a defect in material or workmanship.

This Express Warranty is VOID if the product is altered, modified, or used in the manner it was not designed for, also including unauthorized repairs, or using maintenance and repair parts other than those supplied by BreatheSafe.

BreatheSafe responsibilities

If there is a defect in material or workmanship not caused by the excluded failures during the warranty period, BreatheSafe will either replace the defective goods at our Queensland factory, or designated branch. *

Alternatively, BreatheSafe may elect to provide new replacement parts, BreatheSafe approved repair parts or assembled components needed to repair the defect. BreatheSafe reserves the right to provide a refund of the purchase price in lieu of replacement or repair at BreatheSafe's discretion. The replacement or repaired product will be sent to you freight prepaid by the customer or made available for pick-up on site.

Users Responsibilities

The customer should ensure that the system is maintained according to BreatheSafe service requirements and only authorized parts must be used to service and maintain BreatheSafe systems. In the event of a suspected warranty claim, BreatheSafe should be contacted in the first instance to arrange the repair or to assist with diagnosis. Claims should be made within one week of the repair.

After contacting BreatheSafe, you may be required to deliver or send the parts to BreatheSafe's Queensland factory or designated branch. * Link to online Warranty claim form <https://www.breathe-safe.com.au/warranty/>

Exclusion and Limitations on Damages and Remedies

This warranty is provided in lieu of all other warranties, written or oral, whether expressed by affirmation, promise, description, drawing, model, or sample. To the extent allowed by law, all warranties other than this warranty, whether express or implied, including implied warranties of fitness for a particular purpose, are disclaimed. The maximum liability of BreatheSafe under this warranty shall not exceed the original purchase price of the product. Interference with the equipment by or abuse, or by operating the equipment at ambient temperatures or with electrical power characteristics outside the ranges indicated in our specification shall be excluded from this warranty, as shall consequential damages.

Excluded from any express warranty are costs incurred in relation to service outside our factory our designated service branch, including traveling time, waiting time, transport costs, mechanical and overtime payments required. As per Australian Consumer Law: You are entitled to choose a refund or replacement for major failures with goods. If a failure with the goods or service does not amount to a major failure, you are entitled to have the failure rectified in a reasonable time. If this is not done, you are entitled to a refund for the goods and to cancel the contract for the service and obtain a refund of any unused portion. You are also entitled to be compensated for any other reasonably foreseeable loss or damage from a failure in the goods or service.

***This express warranty gives you specific legal rights, and you may also have other rights that vary from country to country.**